

**STATE PROJECT NO. 337-04-0011 (CM)
 WEST CARROLL PARISH LINE - JCT LA 577
 LA 877
 EAST CARROLL PARISH**

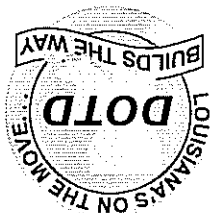

**STATE OF LOUISIANA
 DEPARTMENT OF TRANSPORTATION AND
 DEVELOPMENT
 CONSTRUCTION PROPOSAL**

**STATE PROJECT NO. 337-04-0011
TABLE OF CONTENTS**

Page No.

Title Sheet.....	A-1
Table of Contents.....	B-1
Notice to Contractors.....	C-1 thru C-2
Special Provisions.....	D-1 thru D-2
Supplemental Specifications:	
Supplemental Specifications for 2006 Standard Specifications (08/08).....	E-1 thru E-36
Plans (17 sheets).....	F-1 thru F-10
Construction Proposal Information or Returnables:	
Title Sheet.....	G-1
Other Project Specific Information or Returnables.....	H-1
Bid Bond.....	I-1 thru I-2
Schedule of Items.....	J-1 thru J-2
Construction Proposal Signature and Execution Form.....	J-1 thru J-2

NOTICE TO CONTRACTORS (08/07)

Sealed bids for construction of the following project will be received by the Louisiana Department of Transportation and Development (DOTD), 8010 Desiard St. Monroe, Louisiana until 1:30 p.m. on **August 18, 2009**, at which time and place bids will be publicly opened and read. No bids will be received after 1:30 p.m. Any person requiring special accommodations shall notify the Department of Transportation and Development (DOTD) at (318) 342-0100 not less than 3 business days before bid opening.

STATE PROJECT NO. 337-04-0011 (CM)

DESCRIPTION: WEST CARROLL PARISH LINE – JCT LA 577

ROUTE: LA 877

PARISH: EAST CARROLL

LENGTH: 0.610 miles.

TYPE: ASPHALT SURFACE TREATMENT

LIMITS: State Project No. 337-04-0011: WEST CARROLL PARISH LINE – JCT LA 577

ESTIMATED COST RANGE: \$0,000.00 TO \$50,000.00

PROJECT ENGINEER: MR. WILLIAM STODGHILL, P.E., 108 Hwy 80 East, Tallulah, LA

71282, TELEPHONE (318) 574-4661

PROJECT MANAGER: PAUL COLQUETTE

COST OF PROPOSAL FORMS: FREE

COST OF PLANS: \$ Included in proposal (no additional charge). FREE

Bids must be prepared and submitted in accordance with Section 102 of the 2006 Louisiana Standard Specifications for Roads and Bridges as amended by the project specifications, and must include all information required by the proposal.

NOTICE TO CONTRACTORS (CONTINUED)

Plans and/or proposals may be obtained from the District Administrator's office in Monroe, or by contacting DOTD; Email: marshahhh111@la.gov, Phone (318) 342-0103, FAX: (318) 342-0260, or by written requests sent to the Louisiana Department of Transportation and Development, 8010 Desiard St., Monroe, LA 71211. Proposals will not be issued later than 24 hours prior to the time set for opening bids. Plans and specifications may be seen at the Project Engineer's office. Upon request, the Project Engineer will show the work.

The U. S. Department of Transportation (DOT) operates a toll free "Hotline" Monday through Friday, 8:00 a.m. to 5:00 p.m., eastern time. Anyone with knowledge of possible bid rigging, bidder collusion, or other fraudulent activities should call 1-800-424-9071. All information will be treated confidentially and caller anonymity will be respected.

SPECIAL PROVISIONS

GENERAL BIDDING REQUIREMENTS (08/06): The specifications, contract and bonds governing the construction of the work are the 2006 Edition of the Louisiana Standard Specifications for Roads and Bridges, together with any supplementary specifications and special provisions attached to this proposal.

Bids shall be prepared and submitted in accordance with Section 102 of the Standard Specifications.

The plans herein referred to are the plans approved and marked with the project number, route and Parish, together with all standard or special designs that may be included in such plans. The bidder declares that the only parties interested in this proposal as principals are those named herein; that this proposal is made without collusion or combination of any kind with any other person, firm, association, or corporation, or any member or officer thereof; that careful examination has been made of the site of the proposed work, the plans, Standard Specifications, supplementary specifications and special provisions above mentioned, and the form of contract and payment, performance, and retainage bond; that the bidder agrees, if this proposal is accepted, to provide all necessary machinery, tools, apparatus and other means of construction and will do all work and furnish all material specified in the contract, in the manner and time therein prescribed and in accordance with the requirements therein set forth; and agrees to accept as full compensation therefor, the amount of the summation of the products of the quantities of work and material incorporated in the completed project, as determined by the engineer, multiplied by the respective unit prices herein bid.

It is understood by the bidder that the quantities given in this proposal are a fair approximation of the amount of work to be done and that the sum of the products of the approximate quantities multiplied by the respective unit prices bid shall constitute gross sum bid, which sum shall be used in comparison of bids and awarding of the contract.

The bidder further agrees to perform all extra and force account work that may be required on the basis provided in the specifications.

The bidder further agrees that within 15 calendar days after the contract has been transmitted to him, he will execute the contract and furnish the Department satisfactory surety bonds.

If this proposal is accepted and the bidder fails to execute the contract and furnish bonds as above provided, the proposal guaranty shall become the property of the Department; otherwise, said proposal guaranty will be returned to the bidder; all in accordance with Subsection 103.04.

MAINTENANCE OF TRAFFIC (11/13/08): Subsection 104.03 of the 2006 Standard Specifications is amended to include the following requirements.

The contractor shall provide for and maintain through and local traffic at all times and shall conduct his operations in such manner as to cause the least possible interference with traffic at junctions with roads, streets and driveways.

During asphaltic surface treatment operations, the contractor will be permitted to interrupt traffic for periods not exceeding 50 consecutive minutes in each 60-minute period.

The contractor shall conduct his paving operations on one side of the roadway at a time. The side of the roadway, including shoulder, that is open to traffic shall be clear at all times.

When the plans show asphaltic concrete pavement layers to be placed in thicknesses of 2 inches (50 mm) or less, the contractor will be permitted to pave in one lane for a full day; the adjacent lane may be paved the following workday. When pavement layers are greater than 2 inches (50 mm) thickness, the contractor shall use a Wedged Joint and will be permitted to

**STATE PROJECT NO. 337-04-0011
SPECIAL PROVISIONS**

pave in one lane for a full day; the adjacent lane shall be paved the following day or place approximately 1/2 of each day's production in one lane and the remainder in the adjacent lane. At the end of each day's paving operations, temporary pavement markings shall be in place and proper signs and barricades displayed. During the period that all lanes are open to traffic, the contractor shall neither store material nor park equipment on roadway shoulders.

SUBLETTING OF CONTRACT (01/83): In accordance with Subsection 108.01 of the Standard Specifications, the following items are designated as "Specialty Items":
Item 731-02-00100, ReflectORIZED Raised Pavement Markers
Item 737-01-00100, Painted Traffic Striping (Solid Line) (4" Width)
Item 737-02-00100, Painted Traffic Striping (Broken Line) (4" Width)

PAYMENT ADJUSTMENT (05/06): Section 109, Measurement and Payment of the Standard Specifications is amended to add the following.

This project is not designated for payment adjustments for asphalt cements or fuels.

CONTRACT TIME (03/05): The entire contract shall be completed in all details and ready for final acceptance in accordance with Subsection 105.17(b) within Twenty (20) working days. Prior to assessment of contract time, the contractor will be allowed 30 calendar days from the date stipulated in the Notice to Proceed to commence with portions of the contract work including but not limited to assembly periods, preparatory work for materials fabrications such as test piles, or other activities which hinder progress in the beginning stages of construction. Prior to issuance of the Notice to Proceed, the Department will consider extending the assembly period upon written request from the contractor justifying the need for additional time.

The contractor shall be responsible for maintenance of traffic from the beginning of the assembly period. During the assembly period, the contractor will be allowed to do patching and other maintenance work necessary to maintain the roadway with no time charges when approved by the engineer.

If the contractor begins regular construction operations prior to expiration of the assembly period, the assessment of contract time will commence at the time construction operations are begun.

LOUISIANA
DEPARTMENT OF TRANSPORTATION AND DEVELOPMENT
SUPPLEMENTAL SPECIFICATIONS
(FOR 2006 STANDARD SPECIFICATIONS)

TABLE OF CONTENTS

PART I – GENERAL PROVISIONS

SECTION 101 – GENERAL INFORMATION, DEFINITIONS, DEFINITIONS, AND TERMS 1
Subsection 101.03 – Definitions 1

SECTION 102 – BIDDING REQUIREMENTS 1

Subsection 102.09 – Proposal / Bid Guaranty 1

SECTION 107 – LEGAL RELATIONS AND RESPONSIBILITY TO PUBLIC 1

Subsection 107.05 – Federal Aid Participation 2

SECTION 108 – PROSECUTION AND PROGRESS 2

Subsection 108.04 – Prosecution of Work 2

PART II – EARTHWORK

SECTION 202 – REMOVING OR RELOCATING

STRUCTURES AND OBSTRUCTIONS

Subsection 202.06 – Plugging or Relocating Existing Water Wells 2

PART III – BASE COURSES

SECTION 302 – CLASS II BASE COURSE

Subsection 302.01 – Description 2

Subsection 302.02 – Materials 2

Subsection 302.04 – General Construction Requirements 2

Subsection 302.05 – Mixing 3

Subsection 302.06 – Transporting and Placing on Subgrade 3

Subsection 302.07 – Compacting and Finishing 3

Subsection 302.09 – Protection and Curing 4

Subsection 302.12 – Acceptance Requirements 4

SECTION 305 – SUBGRADE LAYER

Subsection 305.06 – Payment 4

SECTION 307 – PERMEABLE BASES

Subsection 307.02 – Materials 5

SECTION 308 – IN-PLACE CEMENT TREATED BASE COURSE

All Subsections 5

Supplemental Specifications – Table of Contents (05/09)

SECTION 901 - PORTLAND CEMENT CONCRETE
 Subsection 901.06 - Quality Control of Concrete.....22
 Subsection 901.08 - Composition of Concrete.....22

PART IX - PORTLAND CEMENT CONCRETE

SECTION 804 - DRIVEN PILES
 Subsection 804.08 - Construction Requirements.....22

PART VIII - STRUCTURES

SECTION 701 - CULVERTS AND STORM DRAINS
 All Subsections.....7
SECTION 704 - GUARD RAIL
 Subsection 704.03 - General Construction Requirements.....18
SECTION 706 - CONCRETE WALKS, DRIVES AND INCIDENTAL PAVING
 All Subsections.....18
SECTION 713 - TEMPORARY TRAFFIC CONTROL
 Subsection 713.06 - Pavement Markings.....20
SECTION 729 - TRAFFIC SIGNS AND DEVICES
 Subsection 729.02 - Materials.....21
 Subsection 729.04 - Fabrication of Sign Panels and Markers.....22

PART VII - INCIDENTAL CONSTRUCTION

SECTION 602 - PORTLAND CEMENT CONCRETE PAVEMENT REHABILITATION
 Subsection 602.17 - Payment.....7

PART VI - RIGID PAVEMENT

SECTION 502 - SUPERPAVE ASPHALTIC CONCRETE MIXTURES
 Subsection 502.02 - Materials.....5
 Subsection 502.14 - Lot Sizes.....6
SECTION 508 - STONE MATRIX ASPHALT
 Subsection 508.01 - Description.....6
 Subsection 508.02 - Materials.....7

PART X – MATERIALS

SECTION 1001 – HYDRAULIC CEMENT
Subsection 1001.01 – Portland Cement.....23

SECTION 1003 – AGGREGATES
Subsection 1003.02 – Aggregates for Portland Cement Concrete and Mortar.....23

SECTION 1005 – JOINT MATERIALS FOR PAVEMENTS AND STRUCTURES
Subsection 1005.04 – Combination Joint Former/Sealer24

SECTION 1006 – CONCRETE AND PLASTIC PIPE
Subsection 1006.09 – Plastic Yard Drain Pipe.....25

SECTION 1013 – METALS
Subsection 1013.09 – Steel Piles.....25

SECTION 1015 – SIGNS AND PAVEMENT MARKINGS
Subsection 1015.04 – Sign Panels.....25
Subsection 1015.05 – Reflective Sheeting26
Subsection 1015.11 – Performed Plastic Pavement Marking Tape.....30

SECTION 1020 – TRAFFIC SIGNALS
Subsection 1020.01 – Traffic Signal Heads.....31
Subsection 1020.04 – Poles for Traffic Signal Systems.....32

**LOUISIANA
DEPARTMENT OF TRANSPORTATION AND DEVELOPMENT
SUPPLEMENTAL SPECIFICATIONS
PART I – GENERAL PROVISIONS**

The 2006 Louisiana Standard Specifications for Roads and Bridges and supplemental specifications thereto are amended as follows.

SECTION 101 – GENERAL INFORMATION, DEFINITIONS, AND TERMS:

Subsection 101.03 – Definitions (07/07), Pages 3 – 13.

Delete the definition for "Proposal/Bid Guaranty" and substitute the following.

Proposal / Bid Guaranty. The required security furnished with a bid. The only form of

security acceptable is a Bid Bond.

SECTION 102 – BIDDING REQUIREMENTS:

Subsection 102.09 – Proposal / Bid Guaranty (07/07), Page 19.

Delete the contents of this subsection and substitute the following.

PROPOSAL/BID GUARANTY. Each bid shall be accompanied by a proposal/bid guaranty in an amount not less than five percent of the total bid amount when the bidder's total bid amount as calculated by the Department is required for projects when the bidder's total bid amount as calculated by the Department is \$50,000 or less. The official total bid amount for projects that include alternates is the total of the bidder's base bid and all alternates bid on and accepted by the Department. The proposal/bid guaranty submitted by the bidder shall be a bid bond made payable to the contracting agency as specified on the bid bond form provided in the construction proposal. No other form of security will be accepted.

The bid bond shall be on the "Bid Bond" form provided in the construction proposal, on a form that is materially the same in all respects to the "Bid Bond" form provided, or on an electronic form that has received Department approval prior to submission. The bid bond shall be filled in completely, shall be signed by an authorized officer, owner or partner of the bidding entity, or each entity representing a joint venture; shall be signed by the surety's agent or attorney-in-fact; and shall be accompanied by a notarized document granting general power of attorney to the surety's signer. The bid bond shall not contain any provisions that limit the face amount of the bond.

The bid bond will be written by a surety or insurance company that is in good standing and currently licensed to write surety bonds in the State of Louisiana by the Louisiana Department of Insurance and also conform to the requirements of LSA-R.S. 48:253. All signatures required on the bid bond may be original, mechanical reproductions, facsimiles or electronic. Electronic bonds issued in conjunction with electronic bids must have written Departmental approval prior to use. The Department will make a listing of approved electronic sureties providers on the Bidx.com site.

SECTION 107 – LEGAL RELATIONS AND RESPONSIBILITY TO PUBLIC:

Subsection 107.05 – Federal Aid Participation (04/08), Pages 57 and 58.

Delete the second paragraph.

SECTION 108 – PROSECUTION AND PROGRESS:

Subsection 108.04 – Prosecution of Work (03/05) Pages 74 and 75.

Add the following sentence to the third paragraph of Heading (b).

Should the surety or the Department take over prosecution of the work, the contractor shall remain disqualified for a period of one year from the completion of the project, unless debarment proceedings are instituted.
When the Department of Transportation and Development is not the contracting agency on the project, the second paragraph under Heading (c) is deleted.

PART II – EARTHWORK

SECTION 202 – REMOVING OR RELOCATING STRUCTURES AND OBSTRUCTIONS:

Subsection 202.06 – Plugging or Relocating Existing Water Wells (03/04), Page 105.

Delete the first sentence and substitute the following.

All abandoned wells shall be plugged and sealed at the locations shown on the plans, or as directed by the engineer, in accordance with the "Water Well Rules, Regulations, and Standards, State of Louisiana." This document is available at the Department of Transportation and Development, Water Resources Section, P. O. Box 94245, Baton Rouge, Louisiana 70804-9245. The Water Resource Section's telephone number is (225) 274-4172.

PART III – BASE COURSES

SECTION 302 – CLASS II BASE COURSE:

Subsection 302.01 – Description (12/08), Page 150.

Add the following to the third paragraph:

(6) Blended Calcium Sulfate

Subsection 302.02 – Materials (12/08), Pages 150 and 151.

Add the following to the first paragraph:

Blended Calcium Sulfate

1003.01 & 1003.03 (e)

Subsection 302.04 – General Construction Requirements (12/08), Page 152.

Add the following:

Blended calcium sulfate will be allowed in areas of new alignment, fill areas, and cut areas less than one foot.

In cut areas greater than one foot (300 mm), an additional one foot (300 mm) of undercut will be required prior to placement of BCS. The additional undercut area shall be replaced with non-plastic sand embankment and encapsulated with a Class D geotextile fabric. The additional

non-plastic material, geotextile fabric, and undercut shall be at no additional cost to the Department.
Blended calcium sulfate will not be allowed in areas needed to facilitate traffic control or when a soil cement base course is specified in the plans. Blended calcium sulfate shall not be placed within 10 feet (3.0 m) of metal drainage structures. The contractor will be allowed to substitute any untreated Class II base course material listed in Subsection 302.01. Flowable fill under Section 710, or other approved backfill material in Section 701 shall be used to backfill the drainage structure.

Subsection 302.05 – Mixing (08/06) (12/08), Pages 152 and 153.

Delete the first sentence of Subheading (b)(1), In-Place Mixing, and substitute the following.

In-place mixing shall conform to Heading (a)(1) except that the percentage of Type I portland cement required will be 6 percent by volume.

Add Heading (d) as follows:

(d) Blended Calcium Sulfate: Calcium sulfate shall be blended with an approved aggregate or lime prior to placement. The blended calcium sulfate material shall be uniformly mixed and sampled from dedicated stockpiles. Gradation sampling in accordance with Subsection 1003.03 shall be taken from the dedicated stockpiles at the point of material origin.

Subsection 302.06 – Transporting and Placing on Subgrade (12/08), Page 154.

Add the following:

Water shall be added or other suitable means taken to prevent dust during the transporting and placing of dry blended calcium sulfate.

Subsection 302.07 – Compacting and Finishing (12/08), Pages 154 and 155.

Add Heading (e) as follows:

(e) Blended Calcium Sulfate: Blended calcium sulfate shall be placed and spread on the subgrade and compacted to produce layers not exceeding 12 inches (300 mm) compacted thickness. During placement the material shall be thoroughly wetted by application of water to maintain 2 to 4 percent above optimum moisture. After application of water, allow the moisture to reach equilibrium in the base before applying rolling techniques. Rolling of BCS is required to the edge of the embankment or subgrade. Each layer shall be compacted to at least 95 percent of maximum dry density or compacted by an approved established rolling pattern determined by the project engineer before the next layer is placed. Optimum moisture and maximum density shall be determined in accordance with DOTD TR 418 Method G modified to include a maximum drying temperature of 140°F (60°C).

Add Heading (f) as follows:

(f) Proof Rolling: Proof rolling shall be done by a load of 25 tons (25 Mg) in a 12 to 14 cubic yard (9 to 10.5 cubic meters) tandem dump truck with ten wheels or approved loaded truck

determined by the project engineer. Proof rolling shall be a minimum of 5 passes in each direction at the same locations and at a maximum vehicle speed of 3 mph (4.8 km/h). All BCS base will be tested by proof rolling prior to placement of surfacing material, including asphalt binder. Any irregularities or soft spots shall be corrected prior to placement of the surfacing material. Any rain event on the project site between the proof rolling and placement of the surfacing will require an additional proof rolling as noted above.

Subsection 302.09 – Protection and Curing (12/08), Page 155.

Add Heading (c) as follows:

(c) Blended Calcium Sulfate: Protection and curing of blended calcium sulfate shall be in accordance with Subsection 302.09(b).

Subsection 302.12 – Acceptance Requirements (12/08), Pages 156 – 161.

Add the following to Heading (a):

The acceptance requirements for blended calcium sulfate base course shall be the same as stone base course with the following modifications. Upon completion of compaction operations, the density will be determined in accordance with DOTD TR 401 except that all moisture content determinations for density calculations shall be conducted by oven drying the material for 24 hours at 140°F (60°C). A forced draft type oven capable of maintaining the temperature shall be provided by the contractor for field moisture content determination for density control.

SECTION 305 – SUBGRADE LAYER:

Subsection 305.06 – Payment (01/08), Page 184.

Delete the contents of this subsection and substitute the following.

305.06 Payment. Payment for subgrade layer will be made at the contract unit price which includes lime, lime treatment, cement, cement treatment, water, stone, recycled portland cement concrete, crushed slag, blended calcium sulfate, asphaltic concrete, and asphalt curing membrane or prime coat, subject to the payment adjustment provisions of Section 1002 for specification deviations of asphalt materials and Subsection 303.11(a) for density deficiencies of cement treated materials. Adjustments in pay for increase or decrease in the percent cement ordered by the engineer will be in accordance with Subsection 303.13. Adjustments in pay for increase or decrease in the percent lime ordered by the engineer will be based on the price of lime shown on paid invoices (total of all charges). The Materials and Testing Section will provide the payment adjustment percentage for properties of asphalt materials. Payment for geotextile fabric will be included in the contract unit price for subgrade layer.

Payment will be made under:

Item No.	Pay Item	_____ in (mm) Thick	Pay Unit
305-01	Subgrade Layer		Square Yard (Sq m)

SECTION 307 – PERMEABLE BASES:

Subsection 307.02 – Materials (09/07), Pages 187 and 188.

Delete the contents of Subheading (b), Asphalt, and substitute the following.

(b) Asphalt: The asphalt for asphalt treated permeable base shall be an approved polymer modified asphalt cement, PG 76-22m, or PG 82-22m complying with Section 1002. The percentage of asphalt cement shall be 2.0 percent to 4.0 percent by weight (mass) of the total mixture. Asphalt cement content and mixing process shall be such that all aggregates are visibly coated. The mixture shall retain 90 percent coating when tested in accordance with DOTD TR 317.

A job mix formula shall be submitted and approved in accordance with Section 502.

SECTION 308 – IN-PLACE CEMENT TREATED BASE COURSE:

All Subsections within Section 308 – (07/07), Pages 191 – 198.

Whenever the reference to “DOTD TR-432, Method D” is used, it shall mean “DOTD TR-432”.

PART V – ASPHALTIC PAVEMENTS

SECTION 502 – SUPERPAVE ASPHALTIC CONCRETE MIXTURES:

Subsection 502.02 – Materials (08/06) (11/07), Pages 210 – 213.

Delete Table 502-2, Superpave Asphalt Cement Usage under Subheading (a) and substitute the following.

Table 502-2

Superpave Asphalt Cement Usage

Current Traffic Load Level	Mixture Type	Grade of Asphalt Cement
Level 1	Wearing Course	PG 70-22m
	Binder Course	PG 70-22m
	Base Course	PG 64-22
Level 2	Wearing Course	PG 76-22m
	Binder Course	PG 76-22m
Level A	Incidental Paving	PG 70-22m

Note: A PG 82-22 m, Waste Tire Rubber Modified Asphalt, may be substituted for any other grade of asphalt cement.

Delete Table 502-3, Aggregate Friction Rating under Subheading (c)(1) and substitute the following.

Table 502-3

Aggregate Friction Rating

Friction Rating	Allowable Usage
I	All mixtures
II	All mixtures
III	All mixtures, except travel lane wearing courses with plan ADT greater than 7000 ¹
IV	All mixtures, except travel lane wearing courses ²

¹ When plan current average daily traffic (ADT) is greater than 7000, blending of Friction Rating III aggregates and Friction Rating I and/or II aggregates will be allowed for travel lane wearing courses at the following percentages. At least 30 percent by weight (mass) of the total aggregate shall have a Friction Rating of I, or at least 50 percent by weight (mass) of the total aggregate shall have a Friction Rating of II. The frictional aggregates used to obtain the required percentages shall not have more than 10 percent passing the No. 8 (2.36 mm) sieve.

² When the average daily traffic (ADT) is less than 2500, blending of Friction Rating IV aggregates with Friction Rating I and/or II aggregates will be allowed for travel lane wearing courses at the following percentages. At least 50 percent by weight (mass) of the total aggregate in the mixture shall have a Friction Rating of I or II. The frictional aggregates used to obtain the required percentages shall not have more than 10 percent passing the No. 8 (2.36 mm) sieve.

Subsection 502.14 – Lot Sizes (11/07), Pages 232 and 233.

Delete the first sentence of the first paragraph and substitute the following.

A lot is a segment of continuous production of asphaltic concrete mixture from the same job mix formula produced for the Department at a specific plant, delivered to a specific DOTD project.

SECTION 508 – STONE MATRIX ASPHALT:

Subsection 508.01 – Description (09/07), Page 274.

Delete this subsection and substitute the following.

508.01 DESCRIPTION. This work consists of furnishing and constructing Stone Matrix Asphalt (SMA) which is a plant mixed asphalt concrete wearing course for high traffic applications. This mixture is a rut resistant hot mix design with stone on stone contact. The mixture shall be composed of a PG 76-22m, or PG 82-22m asphalt cement and a gap graded coarse aggregate structure. Mineral filler and/or fibers shall be used to control draindown. This work shall be in accordance with these specifications, plan details, and as directed. All requirements of Section 502 apply to Stone Matrix Asphalt, except as modified herein. All plant and paving equipment and processes must meet the requirements of Section 503. Mixture used for shoulder may be Stone Matrix Asphalt or any mixture type shown in Table 502-5.

Subsection 508.02 – Materials (09/07), Page 274.

Delete the contents of subheading (a), Asphalt Cement and substitute the following.

(a) Asphalt Cement: Asphalt cement shall be PG 76-22m, or PG 82-22m as listed on QPL 41 and complying with Section 1002.

PART VI – RIGID PAVEMENT

SECTION 602 – PORTLAND CEMENT CONCRETE PAVEMENT

REHABILITATION:

Subsection 602.17 – Payment (09/07), Pages 341 – 344.

Delete the last paragraph of Subheadings (d), Full Depth Corner Patching of Jointed Concrete Pavement, (e) Full Depth Patching of Jointed Concrete Pavement, and (g) Patching Continuously Reinforced Concrete Pavement, and substitute the following.

Payment for deteriorated base course removed as directed by the engineer and replaced with concrete will be made as follows: The value per inch (mm) thickness will be determined by dividing the contract unit price per square yard (sq m) by the plan thickness. Thickness of patches will be measured from the surface that exists at the time of patching. Payment for the additional thickness will be made at 50 percent of the value per inch (mm) thus determined.

PART VII – INCIDENTAL CONSTRUCTION

SECTION 701 – CULVERTS AND STORM DRAINS:

All Subsections within Section 701 (08/07), Pages 347 – 358.

Delete Section 701, Culverts and Storm Drains and substitute the following.

SECTION 701

CULVERTS AND STORM DRAINS

701.01 DESCRIPTION. This work consists of furnishing, installing, and cleaning pipe, pipe arch, storm drains and sewers, also referred to as culverts or conduit, in accordance with these specifications and in conformity with lines and grades shown on the plans or established.

701.02 MATERIALS. Materials shall comply with the following sections and subsections:

203.06(a)	Usable Soil
203.06(b)	Selected Soil
203.10	Plastic Soil Blanket
702.02	Mortar
710	Flowable Fill
901	Portland Cement Concrete
1003.01 & 1003.04(d)	Reclaimed Asphaltic Pavement (RAP)
1003.03(b)	Stone
1003.03(c)	Recycled Portland Cement Concrete
1003.07	Granular Material
1003.08	Bedding Material
1006.02	Concrete Sewer Pipe
1006.03	Reinforced Concrete Pipe
1006.04	Reinforced Concrete Pipe Arch
1006.06	Gasket Materials
1006.07	Plastic Pipe
1006.07(d)(4)	Split Plastic Coupling Bands
1006.09	Plastic Yard Drain Pipe
1007.02	Bituminous Coated Corrugated Steel Pipe and Pipe Arch
1007.04	Structural Plate for Pipe, Pipe Arch and Arch
1007.05	Corrugated Aluminum Pipe and Pipe Arch
1007.09	Coupling Bands
1009	Reinforcing Steel
1019	Geotextile Fabric

(a) Side Drain Pipe or Side Drain Pipe Arch: When the item for Side Drain Pipe or Side Drain Pipe Arch is included in the contract, the contractor has the option of furnishing reinforced concrete pipe or reinforced concrete pipe arch, or plastic pipe, as allowed by EDSM II.2.1.1 or unless otherwise specified.

(b) Cross Drain Pipe or Cross Drain Pipe Arch: When the item for Cross Drain Pipe or Cross Drain Pipe Arch is included in the contract, the contractor has the option of furnishing reinforced concrete pipe or reinforced concrete pipe arch, corrugated metal pipe or corrugated metal pipe arch, or plastic pipe, as allowed by EDSM II.2.1.1 or unless otherwise specified.

(c) Storm Drain Pipe or Storm Drain Pipe Arch: When the item for Storm Drain Pipe or Storm Drain Pipe Arch is included in the contract, the contractor has the option of furnishing reinforced concrete pipe or reinforced concrete pipe arch, or plastic pipe, as allowed by EDSM II.2.1.1 or unless otherwise specified.

(d) Yard Drain Pipe: When the item for Yard Drain Pipe is included in the contract, the contractor has the option of furnishing concrete sewer pipe, plastic yard drain pipe or plastic pipe in accordance with Section 1006 unless otherwise specified.

(e) Material Type Abbreviations:

(1) Reinforced Concrete Pipe:

RCP Reinforced Concrete Pipe
RCPA Reinforced Concrete Pipe Arch

(2) Corrugated Metal Pipe:

CAP Corrugated Aluminum Pipe
CAPA Corrugated Aluminum Pipe Arch
CMP Corrugated Metal Pipe
CMPA Corrugated Metal Pipe Arch

CSP Corrugated Steel Pipe
CSPA Corrugated Steel Pipe Arch
BCCSP Bituminous Coated Corrugated Steel Pipe
BCCSPA Bituminous Coated Corrugated Steel Pipe Arch

(3) Plastic Pipe:

PP Plastic Pipe
PVC Polyvinyl Chloride Pipe
RPVCP Ribbed Polyvinyl Chloride Pipe
CPPEPDW Corrugated Polyethylene Pipe Double Wall

(f) Joint Type Abbreviations:

T1 Type 1 Joint
T2 Type 2 Joint
T3 Type 3 Joint

(g) Quality Assurance for Pipe: Manufacturing plants will be periodically inspected for compliance with specified manufacturing methods, and material samples will be randomly obtained for laboratory testing for verification of manufacturing lots. Materials approved at the manufacturing plant will be subject to visual acceptance inspections at the jobsite or point of delivery.

701.03 EXCAVATION. For all pipe, when the sides of the trench are stable as evidenced by the sides of the trench being able to maintain a vertical cut face, the minimum trench width at the bottom of the excavation will be 18 inches (460mm) on either side of the outside diameter of the pipe. If the sides of the trench are unstable, the width of the trench at the bottom of the excavation, for plastic or metal pipe, shall be a minimum width of at least 18 inches (460mm) or one pipe diameter on each side of the outside diameter of the pipe, which ever is greater. Surplus material or excavated material that does not conform to the requirements of Subsection 203.06(a) shall be satisfactorily disposed of in accordance with Subsection 202.02. Moisture controls including backfill materials selection and dewatering using sumps, wells, well points or other approved processes may be necessary to control excess moisture during excavation, installation of bedding, over-excavated trench backfilling, pipe placement and pipe backfill.

(a) Over-excavation: When unsuitable soils as defined in Subsection 203.04 or a stable, non-yielding foundation cannot be obtained at the established pipe grade, or at the grade established for placement of the bedding, unstable or unsuitable soils below this grade shall be removed and replaced with granular material meeting the requirements of Subsection 1003.07,

bedding materials meeting the requirements of Subsection 1003.08 or Type A backfill. All granular, backfill materials placed below the established pipe or bedding grade shall be placed in lifts not exceeding 8 inches (200 mm) thick and sufficiently compacted by hand or a dynamic mechanical hand compaction device over the surface of each lift to form a stable, non-yielding foundation at the surface of the established bedding or pipe grade.

When rock is encountered, it shall be removed below grade and replaced with material complying with Subsection 1003.07, bedding materials meeting the requirements of Subsection 1003.08 or Type A backfill. The compacted earth cushion shall have a thickness under the pipe of at least 1/2 inch per foot (40 mm/m) of fill height over the top of the pipe with a minimum thickness of 8 inches (200 mm). All granular, backfill materials placed below the established pipe or bedding grade shall be placed in lifts not exceeding 8 inches (200 mm) thick and sufficiently compacted by hand or a dynamic mechanical hand operated compaction device over the surface of each lift to form a stable, non-yielding foundation at the surface of the established bedding or pipe grade.

Materials used to backfill in an over-excavated portion of a trench do not require encasement in a Geotextile Fabric.

Density of approved materials placed in over-excavated trenches will not be measured or determined.

701.04 FORMING PIPE BED. Bedding material, when specified, shall be constructed in accordance with Section 726. Materials allowed for bedding shall be as specified in Subsection 1003.08 or may be Type A backfill materials. When bedding materials are specified, additional excavation shall be performed below established pipe grade and the bedding material placed in lifts not exceeding 8 inches (200 mm) thick and lightly compacted by hand or a dynamic hand compaction device over the surface of each lift.

When the bottom of the pipe is not laid in a trench but is constructed above natural soils, a uniform bed shall be constructed as specified for the bottom of a trench.

Density of approved bedding materials will not be measured or determined.

701.05 LAYING PIPE. Pipe laying shall begin at the downstream end of the line. The pipe shall be in contact with the foundation throughout its length. Bell or groove ends of pipe and outside circumferential laps of riveted metal pipe shall be placed facing upstream. Riveted seam metal pipe shall be placed with longitudinal laps at sides. Pipes in each continuous line shall have the same wall thickness. Metal pipes provided with lifting lugs shall be handled only by these lugs.

After pipe has been laid and before backfill is placed, the engineer will inspect the pipe for alignment, grade, integrity of joints, and coating damage.

701.06 JOINING PIPE.

(a) Joint Usage:

(1) Type 1 (T1) joints shall be used for side drains under drives and similar installations.

(2) Type 2 (T2) joints shall be used for cross drains under roadways, including

turnouts.

(3) Type 3 (T3) joints shall be used for closed storm drain systems, flumes and

siphons.

(b) Concrete Pipe: Concrete pipe may be either bell and spigot, or tongue and groove.

The method of joining pipe sections shall be such that ends are fully entered and inner surfaces are flush and even.

An approved mechanical pipe puller shall be used for joining pipes over 36 inches (900 mm) in diameter. For pipe 36 inches (900 mm) or less in diameter, any approved method for joining pipe may be used which does not damage the pipe.

Joints shall comply with Subsection 1006.05, and shall be sealed with gasket material installed in accordance with the manufacturer's recommendations.

(c) Metal Pipe: Metal pipe shall be firmly joined by coupling bands. Bands shall be centered over the joint.

For Type 1 joints, approved gasket material shall be placed in one corrugation recess on each side of the joint at the coupling band and on each band connection in such manner to prevent leakage.

When Type 2 or 3 joints are specified, joining of metal pipe sections shall conform to the following provisions:

(1) General: Band joints shall be sealed with gasket material. Gasket material shall be placed in accordance with the plan details.

(2) Circular Section: Connecting bands shall be of an approved design and shall be installed in accordance with plan details.

(3) Arch Section: Connecting bands shall be a minimum of 12 inches (300 mm) wide for pipe arch less than 36 inches (900 mm) round equivalent diameter, and a minimum of 21 inches (525 mm) wide for 36 inches (900 mm) round equivalent diameter pipe arch and greater. Bands shall be connected at the ends by approved angle or strap connections. Connecting bands used for 36 inches (900 mm) round equivalent diameter pipe arch and above shall be 2-piece bands.

(d) Plastic Pipe: Joints for plastic pipe shall be either bell and spigot or split coupling bands.

(1) Bell and Spigot Type Joint System: The method of joining pipe sections shall be such that ends are fully entered and inner surfaces are flush and even.

Any approved method for joining pipe may be used which does not damage the pipe.

Joints shall be approved and shall be sealed with a gasket system utilizing gasket material complying with Subsection 1006.06(a).

(2) Split Coupling Type Joint System: Split coupling bands shall comply with all dimensional and material requirements of Subsection 1006.07. The bands shall be centered over the joint. The split coupling band shall be secured to the pipe with a minimum of five stainless steel or other approved corrosion resistant bands.

Joints shall be approved and shall be sealed with gasket material. Gasket material shall be placed in the first two corrugation recesses on each side of the pipe connections. Gasket material shall also be placed on each band connection to prevent leakage. When flexible plastic gasket material is used it shall be a minimum of 1/2 inch (13 mm) in size. The bands shall be tightened to create overlap of the band and shall adequately compress the gasket material.

(e) Connections: Approved connections shall be used when joining new pipes to existing pipes. When concrete collars are required in order to extend the ends of existing pipes that have been damaged or to join different types or sizes of pipes, the concrete collars shall be constructed in accordance with plan details, the applicable requirements of Section 901, and as directed.

(f) Geotextile Fabric, Pipe Joints: For concrete, metal and plastic pipes, Types 2 and 3 joints shall be wrapped with geotextile fabric for a minimum of 12 inches (300 mm) on each side of joint for pipe 36 inches (900 mm) or less in diameter and a minimum of 18 inches (450 mm) on each side of the joint for pipe greater than 36 inches (900 mm) in diameter. Ends of the fabric shall be lapped at least 10 inches (250 mm). The edges and ends of fabric shall be suitably secured for the entire circumference of the pipe.

701.07 RELAYING PIPE. If specified or directed, existing pipes shall be removed and suitable sections relaid as specified for new pipes.

701.08 BACKFILLING.

(a) General: Prior to backfilling, pipes found to be damaged or out of alignment or grade shall be removed and reinstalled, or replaced.

Type A backfill material shall be stone, recycled portland cement concrete, flowable fill, or RAP.

Type B backfill materials are selected soils. Where Type B backfill materials are called for, Type A backfill materials may be substituted.

When corrugated metal pipe is used, the backfill material shall be tested and shall have a resistivity greater than 1500 ohm-cm and a pH greater than 5 when tested in accordance with DOTD TR 429 and DOTD TR 430 respectively.

When Type A backfill material is used, geotextile fabric surrounding this backfill shall be placed in accordance with Subsection 726.03 between the aggregate backfill material and all other natural or placed soils in the trench or embankment. Care shall be taken to prevent damage to geotextile fabric during placement of backfill material. For concrete pipe, the fabric shall enclose not only the initial backfill but shall be wrapped over the top of the pipe with at least 12 inches (300 mm) of overlap.

When a trench box or trench sheeting is used in unstable soils and/or for worker safety, and when moved during backfilling operations, filling and additional compaction of the disturbed zone of backfill must take place immediately and in a manner acceptable to the engineer.

Initial backfill is a structural backfill encasing the pipe from the bottom of the pipe to the springline for concrete pipe and to a point one foot (0.3 m) above the top of the pipe for both metal and plastic pipe. Final backfill is not a structural backfill and shall extend from the top of the initial backfill to the top of the natural ground or subgrade in cut areas or to the top of existing ground in fill areas. Any fill required above the final backfill is considered and treated as embankment.

(b) Backfill Applications: For projects using A+B+C bidding method where rigid and flexible pavement alternatives are considered, backfill application (2) below, "Cross Drains Under Flexible Pavements", shall apply for either rigid or flexible pavements.

(1) Under Concrete Pavements: Type B backfill may be used as initial and final backfill for all pipes, culverts or drains under concrete pavements. Placement and compaction shall be as specified in Heading (d) below.

(2) Cross Drains Under Flexible Pavements: All reaches, exclusive of those portions of the pipe which are under shoulders, of cross drains and all other culverts, pipes or drains that cross the centerlines of the new roadway or existing roadways, such as intersections and are under flexible pavements shall receive an initial backfill of Type A material. Type B backfill materials may be used as final backfill for all pipes. Placement and compaction shall be as specified in Heading (c) and (d) below. Where the subgrade is above existing ground, embankment material as specified for the remainder of the project shall be used from the top of the final backfill to the top of the established embankment grade.

(3) Other Drains Under Flexible Pavements: All reaches of all culverts, pipes or drains under flexible pavements that do not cross the centerlines of new roadway or centerlines of existing roadways, and exclusive of those portions of the pipe which are totally under shoulders, shall receive an initial and final backfill of Type B material. Placement and compaction shall be as specified in Heading (d) below. Where the subgrade is above existing ground, embankment material as specified for the remainder of the project shall be used from the top of the final backfill to the top of the established embankment grade.

(4) Other Areas: All culverts, pipes or drains in nonpaved areas or paved areas that serve as driveways or shoulders shall receive an initial and final backfill of Type B material. Placement and compaction shall be as specified in Heading (d) below.

(5) Pipes Subject to Construction Traffic: The embankment or pipe backfill shall be constructed to a minimum of 24 inches (600 mm) over the pipe before heavy construction equipment is allowed to cross the installation. Where practical, installations with less than 24 inches (600 mm) of cover over the top of the pipe shall be constructed after heavy hauling is completed over the pipe location. After completion of hauling operations, the contractor shall remove excess cover material. Pipe damaged by hauling and backfilling operations shall be removed and reinstalled, or replaced, at no direct pay.

(c) Placement and Compaction; Type A Backfill: For all pipes, culverts and conduits under paved and nonpaved areas, where Type A backfill material is used, the Type A backfill shall be thoroughly hand compacted under the pipe haunches and then dynamically compacted in layers not exceeding 8 inches (200 mm) compacted thickness. Compaction under the haunches of the pipe shall initially be by hand tamping or other acceptable means, until a level is reached that the dynamic tamping can commence. Each lift shall be compacted by applying at least eight

passes of a hand operated, dynamic mechanical compaction device over the surface of each lift. With approval of the engineer, layer thickness may be increased to 12 inches (300 mm) with verification of satisfactory installation and performance. If flowable fill is used it shall be furnished, placed and consolidated in accordance with Section 710. The contractor shall control placement operations during initial backfill operations so as not to damage protective coatings on metal pipes. The contractor shall repair damaged coatings at no additional pay.

(d) Placement and Compaction; Type B Backfill: For all pipes, culverts and conduits, where Type B backfill is allowed, the Type B material shall be placed in layers not exceeding 8 inches (200 mm) compacted thickness. Compaction shall be with suitable mechanical equipment. With approval of the engineer, layer thickness may be increased to 12 inches (300 mm) with verification of satisfactory installation and performance.

(e) Placement and Compaction; Trenchless or Partial Trench Condition: All pipes, culverts, drains and conduits placed with any portion of the pipe above existing ground must also comply with Subsections (a),(b) (c) and (d) above for the portion of the pipe within a trench and that portion of the pipe not constructed in a trench. The width of initial and final backfill of that portion above existing ground and not within a trench will be constructed to such a width that the requirements for placement, compaction and density are met.

(f) Density Requirements: The in place density of Type A backfill materials and bedding materials, will not be measured or determined. Type A backfill, exclusive of RAP and flowable fill, shall be placed at or near optimum moisture content determined in accordance with DOTD TR 415 or 418. RAP materials shall be placed and compacted in a slightly moist condition. The maximum dry density of initial or final Type B backfill under all paved areas which are to be under traffic will be determined in accordance with DOTD TR 415 or TR 418 and in-place density determined in accordance with DOTD TR 401. Initial and final Type B backfill under all paved areas, under traffic, shall be placed at or near optimum moisture content determined in accordance with DOTD TR 415 or TR 418. Each layer shall be compacted by approved methods prior to the placement of a subsequent layer. The engineer will approve the compaction method based upon validation that such method, including moisture control, will achieve at least 95 percent of maximum dry density as determined in accordance with DOTD TR 401. With approval of the engineer, density testing may be waived on subsequent layers with backfill installation in accordance with approved compaction methods and continued satisfactory performance.

Initial and final backfill in unpaved areas or paved areas such as shoulders or driveways, shall be placed evenly and compacted along the length of the culvert, pipe or drain from the top of the initial backfill to the top of the subgrade. Layered backfill shall be compacted at least to the density of the adjoining existing soils or the compaction required of the laterally adjoining layers of soil immediately outside the trench for embankment elevations. Initial and final backfill shall be placed and compacted at or near optimum moisture content determined in accordance with DOTD TR 415 or TR 418.

701.09 INSPECTION OF PIPES. After completion of embankment and prior to roadway surfacing, the engineer shall inspect pipes for proper alignment and integrity of joints. Any misaligned pipe or defective joints shall be corrected by the contractor at no direct pay.

(a) Plastic Pipe: Installed plastic pipe shall be tested to ensure that vertical deflections do not exceed 5.0 percent. Maximum allowable deflections shall be governed by the mandrel requirements stated herein.

Deflection tests shall be performed no sooner than 30 calendar days after installation and compaction of backfill. The pipe shall be cleaned and inspected for offsets and obstructions prior to testing.

For pipe 36 inches (900 mm) and less in diameter, a mandrel shall be pulled through the pipe by hand to ensure that maximum allowable deflections have not been exceeded. The mandrel shall be approved by the engineer prior to use. Use of an unapproved mandrel or a mandrel altered or modified after approval will invalidate the test. If the mandrel fails to pass, the pipe is overdeflected.

Unless otherwise permitted, overdeflected pipe shall be uncovered and, if not damaged, reinstalled. Damaged pipe shall not be reinstalled, but shall be removed and replaced with new pipe. Any pipe subjected to any method or process other than removal, which attempts, even successfully, to reduce or cure any overdeflection, shall be removed and replaced with new pipe. The mandrel shall be a rigid, nonadjustable, odd-numbered legged (minimum 9 legs) mandrel having a length not less than its nominal diameter or 24 inches (600 mm), whichever is less. The minimum diameter at any point shall be 5.0 percent less than the base inside diameter of the pipe being tested. The mandrel shall be fabricated of steel, aluminum or other approved material fitted with pulling rings at each end. The nominal pipe size and outside diameter of the mandrel shall be stamped or engraved on some segment other than a runner. A suitable carrying case shall be furnished.

For pipe larger than 36 inches (900 mm) in diameter, deflection shall be determined by a method approved by the engineer. If a mandrel is selected, the minimum diameter, length, and other requirements shall conform to the above requirements.

Mandrel testing shall be conducted by the contractor in the presence of the engineer. Mandrel testing shall be at no direct pay.

(b) Metal Pipe: If the inside diameter of metal pipe or rise dimension of metal pipe arch deflects more than 5.0 percent from original dimensions, they shall be removed and reinstalled, unless they do not rebound or are damaged. Pipe or pipe arch which are damaged or do not rebound shall be removed and replaced at no direct pay. Measurement of deflection will be made by the engineer away from rerolled ends.

701.10 CLEANING PIPES.

(a) Existing Pipes: Pipes designated to be cleaned shall be cleaned of soil, debris and other materials to the invert of the pipe. Designated pipes shall be cleaned by approved methods that will not damage the pipes. Any damage caused by the contractor's operations shall be satisfactorily repaired at no direct pay.

Removed soil, debris and other materials shall be disposed of in accordance with Subsection 202.02 or as otherwise approved in writing.

(b) Contractor Installed Pipes: Prior to final acceptance, pipes shall be cleaned of all debris and soil to the invert of the pipe at no direct pay.

Removed soil, debris and other materials shall be disposed of in accordance with Subsection 202.02 or as otherwise approved in writing.

701.11 STUBBING AND PLUGGING PIPES. When it is required that pipes be plugged, such plugs shall be constructed of Class R concrete complying with Section 901. Thickness of plug and method of construction shall be as directed.
When new pipes are to be stubbed into new or existing pipes or other structures, the connection shall be made with approved mortar complying with Subsection 702.02.

701.12 MEASUREMENT. Pipe, both new and relaid, will be measured in linear feet (lin m) as follows unless stated otherwise.

- (a) Pipe not confined by fixed structures will be measured by the number of joints at the nominal length of each joint.
- (b) Pipe confined by fixed structures will be measured along the pipe between the termini of pipe in structure walls.
- (c) Pipe confined by a fixed structure on one end and unconfined at the other end will be measured along the pipe from the terminus of pipe in the structure wall to the unconfined end of pipe.
- (d) Fabricating of pipe tees, elbows and other fittings will be measured per each fitting. The length of pipe in such fittings will be included in the pay length measurement of pipes of which they form a part.
- (e) Excavation required for installation of pipes will not be measured for payment, except as otherwise specified in Subsection 203.14.
- (f) Furnishing and placing backfill material below existing ground level for pipes will not be measured for payment. Backfill material needed to complete backfill above natural ground and around pipes that extend above natural ground will be measured and payment will be made under applicable earthwork items. When specified, flowable fill will be measured and paid for in accordance with Section 710.
- (g) Plugging and stubbing of pipes will not be measured for payment.
- (h) Cleaning existing pipes will be measured by the length of pipe cleaned and accepted.
- (i) Concrete collars will be measured per each.

701.13 PAYMENT.

(a) Payment for pipe will be made at the contract unit price per linear foot (lin m) of the types and sizes specified.
When plastic pipe is specified on the plans or elected to be used by the contractor, payment will be made at the contract unit price per linear foot (lin m) of the types and sizes specified in accordance with the payment schedule of Table 701-1.

Table 701-1

Payment Schedule for Plastic Pipe

Percent Payment	Stage of Completeness
75	After placement and backfill has been completed
25	After the pipe has met vertical deflection requirements in accordance with Subsection 701.09(a)

(b) Payment for fabricating pipe tees, elbows and other fittings will be made at the contract unit price per each fitting.

(c) When unstable conditions are encountered, the additional excavation will not be measured for payment; however, the additional materials furnished and placed for the pipe foundation will be measured and paid for as follows:

(1) Granular Materials: Payment will be made under the embankment item. The net section volume of the materials will be multiplied by 3 to determine the pay volume. When the contract does not include a pay item for embankment, payment will be made in accordance with Subsection 104.02.

(2) Bedding Material: Measurement and payment will be made in accordance with Section 726. When the contract does not include a pay item for bedding material, payment will be made in accordance with Subsection 104.02.

(d) Payment for cleaning existing pipes will be made at the contract unit price per linear foot (lin m).

(e) Payment for concrete collars will be made at the contract unit price per each.

Payment will be made under:

Item No.	Pay Item	Pay Unit
701-01	Cross Drain Pipe (Size & Type)	Linear Foot (Lin m)
701-02	Cross Drain Pipe Arch (Size & Type)	Linear Foot (Lin m)
701-03	Storm Drain Pipe (Size & Type)	Linear Foot (Lin m)
701-04	Storm Drain Pipe Arch (Size & Type)	Linear Foot (Lin m)
701-05	Side Drain Pipe (Size)	Linear Foot (Lin m)
701-06	Side Drain Pipe Arch (Size)	Linear Foot (Lin m)
701-07	Yard Drain Pipe (Size)	Linear Foot (Lin m)
701-08	Relaying Pipe	Linear Foot (Lin m)
701-09	Fabricating Pipe Fittings	Each
701-10	Reinforced Concrete Pipe (Extension)	Linear Foot (Lin m)
701-11	Reinforced Concrete Pipe Arch (Extension)	Linear Foot (Lin m)
701-12	Corrugated Metal Pipe (Extension)	Linear Foot (Lin m)
701-13	Corrugated Metal Pipe Arch (Extension)	Linear Foot (Lin m)

701-14	Cleaning Existing Pipes	Linear Foot (Lin m)
701-15	Concrete Collar	Each
701-16	Plastic Pipe (Extension)	Linear Foot (Lin m)

SECTION 704 – GUARD RAIL:

Subsection 704.03 – General Construction Requirements (01/05), Pages 368 and 369.

Add the following to Heading (d), Guard Rail End Treatments:

All end treatments shall bear a label indicating the manufacturer and exact product name of the end treatment along with its assigned NCHRP 350 test level. This label shall resist weathering and shall be permanently affixed to the railing in such a way as to be readily visible.

SECTION 706 – CONCRETE WALKS, DRIVES AND INCIDENTAL PAVING:

All Subsections within Section 706 (04/08), Pages 375 – 377.

Delete Section 706, Concrete Walks, Drives and Incidental Paving and substitute the following.

SECTION 706

CONCRETE WALKS, DRIVES AND INCIDENTAL PAVING

706.01 DESCRIPTION. This work consists of furnishing and constructing portland cement concrete walks, handicapped curb ramps, drives and incidental paving slabs in accordance with these specifications and in conformity with lines, grades and dimensions shown on the plans or established.

706.02 MATERIALS. Materials shall comply with the following Section or Subsections.

Portland Cement Concrete (Class M)	901
Joint Filler	1005.01(c)
Reinforcing Steel	1009.01
Curing Materials	1011.01

706.03 CONSTRUCTION REQUIREMENTS.

(a) Excavation: Excavation shall be made to required depth and width. The top of the subgrade shall be shaped and compacted to a firm, even surface conforming to the section shown on the plans. Unsuitable material shall be removed and disposed of in accordance with Subsection 202.02 and replaced with approved material at no direct pay.

(b) Forms: Forms shall be of wood or metal and shall extend the full depth of concrete. Forms shall be straight, clean and of sufficient strength to resist the pressure of concrete. Bracing of forms shall be such that forms remain in horizontal and vertical alignment until their removal.

Concrete may be placed by slip-form methods. Slip-formed concrete shall be placed with an approved machine designed to spread, vibrate, consolidate and finish concrete in one pass of the machine in such manner that minimum hand finishing is necessary. Sliding forms shall be

rigidly held together to prevent spreading of forms. After the passing of the side forms there shall be no noticeable slumping of concrete.

(c) Subgrade: The subgrade shall be thoroughly moistened immediately prior to placing concrete.

(d) Placing and Finishing: Concrete shall be placed on the subgrade, struck off to required thickness and tamped sufficiently to bring the mortar to the surface. The surface shall be finished with a wood float or steel trowel followed by brushing to a slightly rough finish. Joints and edges shall be rounded with an edging tool having a 1/4-inch (6 mm) radius.

(e) Joints:

(1) Expansion Joints: Expansion joints shall be filled with 1/2 inch (13 mm) thick preformed expansion joint filler. Expansion joints shall be installed at maximum 100-foot (30 m) intervals, and between intersecting paving and any fixed structure such as a building, bridge or curbing, and between intersecting paving and the handicapped curb ramps. Expansion joint material shall extend for the full width and depth of paving.

(2) Weakened Plane: Weakened planes shall be formed by a jointing tool or other acceptable means. Weakened planes shall extend into concrete for at least 1/4 of the depth and shall be approximately 1/8 inch (3 mm) wide.

a. Walks: Spacing of weakened planes for walks shall be equal to the width of walk.

b. Drives: A longitudinal weakened plane shall be formed along the centerline of drives more than 16 feet (5 m) wide, and transverse weakened planes shall be formed at not more than 16-foot (5 m) intervals.

c. Incidental Paving: Weakened planes for incidental paving shall be formed at intervals not exceeding 30 times the thickness of the concrete in length or width. Incidental paving poured adjacent to jointed concrete shall be jointed to match existing joints, with intermediate joints formed as necessary not to exceed the maximum joint spacing.

(3) Construction Joints: Construction joints shall be formed around manholes, utility poles, etc., extending into paving and 1/4 inch (6 mm) thick preformed expansion joint filler shall be installed in these joints.

(4) Tie-ins: Tie-ins of existing concrete shall be made by full depth sawing at no direct pay.

(f) Curing: Concrete shall be cured in accordance with Subsection 601.10.

(g) Detectable Warning Surface for Handicap Ramps and At-Grade Sidewalk Intersections: Sidewalks, when intersecting with roadways, shall be equipped with a detectable warning surface consisting of raised truncated domes as a transition between the sidewalk and the street as required by the Americans with Disabilities Act, 28 CFR Part 36, ADA Standards for Accessible Design.

Detectable warnings (truncated domes) shall be installed on the ramp surface over the full width of the ramp throat for a distance of 24 inches (600 mm) in the direction of travel from the back of the curb. Detectable warnings (truncated domes) shall also be installed on at-grade sidewalks intersecting with roadways for a distance of 36 inches (900 mm) in the direction of travel from the end of the sidewalk. Truncated domes shall be laid out on a square grid in order to allow enough space for wheelchairs to roll between the domes.

Light reflectance of the truncated domes and the underlying surface must meet the 70 percent contrast requirement of ADAAG.

706.04 MEASUREMENT. Quantities of concrete walks, drives and incidental paving slabs for payment will be the design quantities as specified on the plans and adjustments thereto. Design quantities will be adjusted if the engineer makes changes to adjust to field conditions, if design errors are proven or if design changes are made. Design areas are based on the horizontal dimensions shown on the plans. Excavation, backfill, reinforcing steel and joint materials will not be measured for payment.

Handicapped curb ramps, including the detectable surface warning system, will be measured per each.

Detectable surface warning systems for at-grade sidewalk intersection will not be measured for payment.

706.05 PAYMENT. Payment for concrete walks, drives and incidental paving will be made on a lot basis at the contract unit price per square yard (sq m), adjusted in accordance with the following provisions. Payment for each lot will be made in accordance with Table 901-6. Size, sampling, and testing of each concrete lot shall be in accordance with the Materials Sampling Manual.

Payment for handicapped curb ramps, including the detectable surface warning system, will be made by each and shall include, but not limited to, curb transitions, detectable warning system, gutter, landing and base.

Payment will be made under:

Item No.	Pay Item	Pay Unit
706-01	Concrete Walk (inch (mm) Thick)	Square Yard (Sq m)
706-02	Concrete Drive (inch (mm) Thick)	Square Yard (Sq m)
706-03	Incidental Concrete Paving	Square Yard (Sq m)
706-04	Handicapped Curb Ramps	Each

SECTION 713 – TEMPORARY TRAFFIC CONTROL:

Subsection 713.06 – Pavement Markings (08/06), Pages 400 – 403.

Delete Table 713-1, Temporary Pavement Markings and substitute the following.

**Table 713-1
Temporary Pavement Markings^{1,2}**

SECTION 729 – TRAFFIC SIGNS AND DEVICES:	PROJECT PROHIBITS		PROJECT		M
	ADT < 150 or (1.2 m) tape on 40- foot (12 m) centers; with "Do Not Pass" and "Pass With Care" signs as required	ADT > 150 (1.2-m) tape on 40- foot (12-m) centers with no passing zone markings	All ADT's with time < 2 weeks	All ADT's with time > 2 weeks	
Divided Multilane Highways	Two-lane Highways	Lane lines 4-foot (1.2m) tape on 40-foot (12 m) tape on 40- foot (12 m) centers; double yellow centerline	Lane lines 4-foot (1.2m) tape on 40-foot (12 m) tape on 40- foot (12 m) centers	Standard lane lines, centerlines, edge lines, and legends and when symbols and legends and symbols.	Standard lane lines, centerlines, edge lines, and legends and symbols.
Undivided Multilane Highways	Two-lane Highways	Lane lines 4-foot (1.2m) tape on 40-foot (12 m) tape on 40- foot (12 m) centers; double yellow centerline	Lane lines 4-foot (1.2m) tape on 40-foot (12 m) tape on 40- foot (12 m) centers	Standard lane lines, centerlines, edge lines, and legends and when symbols and legends and symbols.	Standard lane lines, centerlines, edge lines, and legends and symbols.

¹No-passing zones shall be delineated as indicated whenever a project is open to traffic.
²On all Asphaltic Surface Treatments that are open to traffic and used as a final wearing course or as an interlayer, temporary pavement markings (tabs) on 20-foot (6 m) centers shall be used, in lieu of the 4-foot (1.2 m) tape, on 40-foot (12 m) centers.

Subsection 729.02 – Materials (04/08), Pages 456 and 457.
Delete the contents of Heading (a), Sign and Marker Sheeting, and substitute the following.
(a) Sign and Marker Sheeting: Sheeting material for sign panels, delineators, barricades and other markers shall comply with Section 1015. All permanent signs shall meet the requirements of ASTM D 4956, Type X.

Subsection 729.04, Fabrication of Sign Panels and Markers (04/08), Pages 458 – 460.
Delete the third paragraph of Heading (c), Sheeting Application and substitute the following.
ASTM D 4956 Type X reflective sheeting shall be applied with an orientation determined by the engineer to obtain the optimum entrance angle performance. Fabricated vertical splices in ASTM D 4956 Type X reflective sheeting will be allowed only when the horizontal dimension of the sign face or attached shield is in excess of the maximum manufactured width of the sheeting. Fabricated vertical splices in ASTM D 4956 Type X reflective sheeting will also be allowed when the specified orientation will create excessive sheeting waste.

SECTION 804 – DRIVEN PILES:

Subsection 804.08 – Construction Requirements (04/07), Pages 548 – 554.
Delete the first sentence of Heading (a), Preboring and substitute the following.
Preboring by augering, wet-rotary drilling, or other methods used to facilitate pile driving will not be permitted unless specified in the plans or allowed by the engineer.

Delete the first sentence of Heading (b), Jetting and substitute the following.
Jetting will not be permitted unless allowed in the plans or allowed by the engineer.

SECTION 901 – PORTLAND CEMENT CONCRETE:

Subsection 901.06 – Quality Control of Concrete (08/06), Pages 726 – 731.

Add the following to the contents of Heading (b), Quality Control Tests.

The contractor shall be responsible for monitoring the components (cement, mineral and chemical admixtures, aggregates) in their mix to protect against any changes due to component variations. As component shipments arrive, the contractor shall verify slump, air content and set time by testing at ambient temperatures. The contractor shall make adjustments to the mix design to rectify any changes which would adversely affect constructability, concrete placement or the specifications. The contractor shall submit test results to the Department for review each day of paving. Testing to validate component consistency will be documented on the control logs. Conformance or variation in mix parameters (workability, set times, air content, etc.) shall be noted on the control logs. The contractor shall provide a copy of the proposed testing plan to the engineer for record. Acceptance of the plan does not relieve the contractor's responsibility for consistency.

Subsection 901.08 – Composition of Concrete (12/05), Pages 732 – 734.

Add the following to Heading (a).

The blended cement containing up to 50 percent of grade 100 or grade 120 ground granulated blast-furnace slag must be in compliance with Subsection 1001.04 for portland blast-furnace slag cement.

SECTION 1001 – HYDRAULIC CEMENT:

Subsection 1001.01 – Portland Cement (09/07). Page 749.

Delete the contents of this subsection and substitute the following.

1001.01 PORTLAND CEMENT. Portland cement shall be from an approved source listed in QPL 7 and shall comply with AASHTO M 85.

Alkali content calculated as sodium oxide equivalent shall not exceed 0.60 percent by weight for all types of cement.

SECTION 1003 – AGGREGATES:

Subsection 1003.02 – Aggregates for Portland Cement Concrete and Mortar (07/07).

Pages 763 – 766.

Delete the contents of Heading (c), Aggregates for Types B and D Pavements, and substitute the following.

(c) Aggregates for Types B and D Pavements: For the combined aggregates for the proposed portland cement concrete pavement mix, the percent retained based on the dry weight (mass) of the total aggregates shall meet the requirements of Table 1003-1A for the type of pavement specified in the plans. Additionally, the sum of the percents retained on any two adjacent sieves so designated in the table shall be at least 12 percent of the total combined aggregates. The maximum amount by weight (mass) of deleterious materials for the total aggregate shall be the same as shown in Subsection 1003.02(b).

Table 1003-1A

Aggregates for Types B and D Pavements

U.S. Sieve	Metric Sieve	Percent Retained of Total Combined Aggregates	
		Pavement Type	Type D
2 1/2 inch	63 mm	0	0
2 inch	50 mm	0	0-20
1 1/2 inch	37.5 mm	0-20	0-20
1 inch	25.0 mm	0-20	5-20
3/4 inch	19.0 mm	5-20	5-20
1/2 inch	12.5 mm	5-20	5-20
3/8 inch	9.5 mm	5-20	5-20
No. 4	4.75 mm	5-20	5-20
No. 8	2.36 mm	5-20	5-20
No. 16	1.18 mm	5-20	5-20
No. 30	600 µm	5-20	5-20
No. 50	300 µm	0-20	0-20
No. 100	150 µm	0-20	0-20
No. 200	75 µm	0-5	0-5

Note: For the sieves in the shaded areas, the sum of any two adjacent sieves shall be a minimum of 12 percent of the total combined aggregates.

Each type of aggregate to be used in the proposed mixture shall be sampled and tested individually. The percent of total combined aggregates retained shall be determined mathematically based on the proportions of the combined aggregate blend. All gradation calculations shall be based on percent of dry weight (mass).

SECTION 1005 – JOINT MATERIALS FOR PAVEMENTS AND STRUCTURES:

Subsection 1005.04 – Combination Joint Former/Sealer (11/05), Pages 782 and 783.

Delete Heading (a) and substitute the following.

(a) Description: This joint former/sealer is intended for use in simultaneously forming and sealing a weakened plane in portland cement concrete pavements.

The material shall consist of an elastomeric strip permanently bonded either mechanically or chemically at the top of each of two rigid plastic side frames and covered with a removable plastic top cap. Side frames shall be of such configuration that when the sealer is inserted into plastic concrete and vibrated, a permanent bond forms between side frames and concrete. Delete Heading (b)(1) and substitute the following.

(1) Elastomer: The elastomer strip portion of the material shall be manufactured from vulcanized elastomeric compound using polymerized chloroprene or thermoplastic vulcanizate as the base polymer, and shall comply with the following requirements:

SECTION 1015 – SIGNS AND PAVEMENT MARKINGS:
 Subsection 1015.04 – Sign Panels (05/07), Pages 832 and 833.
 Delete the contents of Heading (a), Permanent Sign Panels and substitute the following.

SECTION 1013 – METALS:
 Subsection 1013.09 – Steel Piles (08/06) Page 822.
 Delete the title and references to “Steel Piles” in this subsection and substitute “Steel H Piles”.

SECTION 1006 – CONCRETE AND PLASTIC PIPE:
 Subsection 1006.09 – Plastic Yard Drain Pipe (06/07), Page 789.
 Delete the contents of Subheading (a)(3), Ribbed Polyvinyl Chloride Pipe (RPVCP) and substitute the following.
 Ribbed Polyvinyl Chloride Pipe (RPVCP): Ribbed Polyvinyl Chloride Pipe shall comply with ASTM F 794, Series 46 or ASTM F 949 (46 psi).

Delete Headings (b)(2) and (b)(3) and substitute the following:
 (2) Bond of Elastomer to Plastic: The force required to shear the elastomer from the plastic shall be a minimum of 5.0 pounds per linear inch (90 g/mm) of sealer when tested in accordance with DOTD TR 636.
 (3) Bond of Plastic to Cement Mortar: This bond will be evaluated and shall meet the following requirements:
 The force required to separate the cement mortar from the plastic shall be a minimum of 5.0 pounds per linear inch (90 g/mm) of sealer when tested in accordance with DOTD TR 636.

Property	ASTM Test Method	Chloroprene Polymerized	Thermoplastic Vulcanizate
Tensile Strength, kPa, Min.	D 412	12,400	7,400
Elongation at Break, % Min.	D 412	200	400
Hardness, Shore A	D 2240	65 ± 10	65 ± 10
Properties after Aging, 70 h @ 100°C	D 573		
Tensile Strength, % Loss, Max.		20	20
Elongation, % loss, Max.		25	25
Hardness, pts. increase, Max.		10	10
Ozone Resistance, 20% strain or bentloop, 300 pphm in air, 70 h @ 40°C	D 1149	no cracks	no cracks
Oil Swell, IRM 903, 70 h @ 100°C, wt change, % Max.	D 471	45	75

(a) Permanent Sign Panels: Flat panels shall be aluminum sheets or plates complying with ASTM B 209, Alloy 6061-T6 or Alloy 5052-H38. Extruded aluminum panels shall comply with ASTM B 221 (ASTM B 221M), Alloy 6063-T6 and after fabrication, have a flatness equal to or less than 0.031 inch per foot of length and 0.004 inch per inch of width.

~~Subsection 1015.05 - Reflective Sheeting (04/08), Pages 833 - 838.~~

~~Delete the contents of this subsection and substitute the following.~~

~~1015.05 REFLECTIVE SHEETING.~~

(a) Permanent and Temporary Standard Sheeting: Reflective sheeting shall be one of the following standard types as specified on the plans and complying with ASTM D 4956 except as modified herein. Permanent warning, regulator, guide and supplemental guide sign sheeting shall meet the requirements of ASTM D 4956 Type X. Reflective sheeting for temporary signs and devices shall meet the requirements of ASTM D 4956 Type III except as noted in Subsection 1015.05(f). Reflective sheeting shall be an approved product listed in QPL 13.

Type III - A high-intensity retroreflective sheeting that is typically encapsulated glass-bead retroreflective material.

Type VI - An elastomeric high-intensity retroreflective sheeting without adhesive. This sheeting is typically a vinyl microprismatic retroreflective material.

Type X - A super high-intensity retroreflective sheeting having highest retroreflectivity characteristics at medium distances. This sheeting is typically an unmetallized microprismatic retroreflective element material.

(b) Fluorescent Pink Retroreflective Sheeting: Signs for temporary control of traffic through incident management areas shall be Type VI fluorescent pink retroreflective sheeting and shall comply with the MUTCD. Temporary traffic control signs for incident management shall be placed to notify motorists of upcoming incidents on the roadway, and shall be removed from public view once the incident has been managed. Physical properties shall comply with ASTM D 4956. Photometric properties shall be as follows.

(1) Retroreflectivity: Minimum Coefficients of Retroreflection shall be as specified in Table 1015-1.

Table 1015-1
Coefficients of Retroreflection for Fluorescent Pink Sheeting¹

Observation Angle, degrees	Entrance Angle, degrees	Fluorescent Pink
0.2	-4	100
0.2	+30	40
0.5	-4	40
0.5	+30	15

¹Minimum Coefficient of Retroreflection (RA) (cd lx⁻¹m⁻²)

(2) Color and Daytime Luminance: Color Chromaticity Coordinates and Daytime Luminance Factors shall be as specified in Table 1015-2.

Table 1015-2
Fluorescent Pink Color Specifications Limits (Daytime)

Luminance Factor, min.	Chromaticity Coordinates (corner points) ¹			
	1	2	3	4
Y%	x	y	x	y
	0.450	0.270	0.590	0.350
25	x	y	x	y
	0.450	0.270	0.644	0.290
	0.536	0.230		

¹The four pairs of chromaticity coordinates measured with CIE 2° Standard Observer and 45/0 (0/45) geometry and CIE D65 Standard Illuminant.

(c) Adhesive Classes: The adhesive required for retroreflective sheeting shall be Class 1 (pressure sensitive) as specified in ASTM D 4956.
 (d) Accelerated Weathering: Reflective sheeting, when processed, applied and cleaned in accordance with the manufacturer's recommendations shall perform in accordance with the accelerated weathering standards in Table 1015-3.

Table 1015-3
Accelerated Weathering Standards¹

Type	Retroreflectivity ²		Colorfastness ³	
	Orange/ Fluorescent	Orange	All colors, except orange/Fluorescent	Orange/ Fluorescent
III	1 year	80 ⁴	3 years	1 year
III (for drums)	1 year	80 ⁴	1 year	1 year
VI	1/2 year	50 ⁵	1/2 year	1/2 year
X	1 year	80 ⁶	3 years	3 years

¹At an angle of 45° from the horizontal and facing south in accordance with ASTM G 7 at an approved test facility in Louisiana or South Florida.

²Percent retained retroreflectivity of referenced table after the outdoor test exposure time specified.

³Colors shall conform to the color specification limits of ASTM D 4956 after the outdoor test exposure time specified.

⁴ASTM D 4956, Table 8.

⁵ASTM D 4956, Table 13.

⁶ASTM D 4956, Table 4.

(e) Expected Sign Life Data and Performance: The sheeting manufacturer shall supply expected retroreflectivity service life curves for each of the following sign sheeting colors: white, green, blue, brown, red, and yellow. The service life curves shall be plots of the 95 percent expected life plotted on an x-y graph with life years on the x-axis and retroreflectivity on the y-axis. The expected life shall account for worst case installations, equivalent to an installation in South Louisiana with the sign facing to the South. The sheeting manufacturer shall also supply a table of expected life values taken from the service life curves for Revision Number 2 to the 2003 Edition of the MUTCD minimum reflectivity requirements published in the Federal Register on December 21, 2007. Reflective sheeting for signs, when processed, applied and cleaned in accordance with the manufacturer's recommendations shall perform outdoors in accordance with the performance standards in Table 1015-4.

Reflective sheeting for drums shall be a minimum of 6 inches (150 mm) wide and shall meet the requirements of ASTM D 4956, Type III, and the Supplementary Requirement S2 for Reboundable Sheeting as specified in ASTM D 4956. Reflective sheeting for traffic cone collars shall meet the requirements of ASTM D 4956, Type III or Type VI.

(g) Sheeting Guaranty. The contractor shall provide the Department with a guaranty from the sheeting manufacturer stating that if the retroreflective sheeting fails to comply with the performance requirements of this subsection, the sheeting manufacturer shall do the following:

(f) Temporary Signs, Barricades, Channelizing Devices, Drums and Cones: Reflective sheeting for temporary signs, barricades and channelizing devices, shall meet the requirements of ASTM D 4956, Type III except that temporary warning construction signs used on the mainline of freeways and expressways shall be fluorescent orange and meet the requirements of ASTM D 4956, Type X.

Reflective sheeting for vertical panels shall meet the requirements of ASTM D 4956, Type III.

¹Percent retained retroreflectivity of referenced table after installation and the field exposure time specified.

²All sheeting shall maintain its structural integrity, adhesion and functionality after installation and the field exposure time specified.

³All colors shall conform to the color specification limits of ASTM D 4956 after installation and the field exposure time specified.

⁴ASTM D4956, Table 8.

⁵ASTM D 4956, Table 4.

Type	Orange/ Fluorescent Orange	All colors, except orange/Fluorescent Orange	Colorfastness ³
	3 years	10 years	
III	80 ⁴	80 ⁴	3 years
X	3 years	80 ⁵	7 years
			3 years

Reflective Sheeting Performance Standards

Table 1015-4

Table 1015-5

Manufacturer's Guaranty-Reflective Sheeting

Type	Manufacturer shall restore the sign face in its field location to its original sheeting required to restore the effectiveness at no cost to the Department if failure occurs during the time period' as specified below	Orange/Fluorescent	All colors, except Orange/Fluorescent	All colors, except orange/Fluorescent Orange
		< 3 years	< 7 years	7-10 years
III		< 3 years	< 7 years	7-10 years
X		< 3 years	< 5 years	5-7 years

From the date of sign installation.

Replacement sheeting for sign faces, material, and labor shall carry the unexpired guaranty of the sheeting for which it replaces.

The sign fabricator shall be responsible for dating all signs with the month and year of fabrication at the time of sign fabrication. This date shall constitute the start of the guaranty obligation period.

Subsection 1015.11 - Preformed Plastic Pavement Marking Tape (06/07), Pages 842 - 844.
Delete the contents of this subsection and substitute the following:
1015.11 PREFORMED PLASTIC PAVEMENT MARKING TAPE.

(a) General: Preformed plastic pavement marking tape shall be approved products listed on QPL 64 and shall comply with ASTM D4505 Retroreflectivity Level I or Level II, or DOTD Intersection Grade (as specified below), except as modified herein. The marking tape shall be Class 2 or 3. The type and color shall be in accordance with the plans and the MUTCD.
(b) Thickness: All preformed plastic pavement marking tape shall have a minimum overall thickness of 0.060 inches (1.5 mm) when tested without the adhesive.
(c) Friction Resistance: The surface of the Retroreflectivity Level II preformed plastic pavement marking tape shall provide a minimum frictional resistance value of 35 British Polish Number (BPN) when tested according to ASTM E303. The surface of the Retroreflectivity Level I and DOTD Intersection Grade preformed plastic pavement marking tape shall provide a minimum frictional resistance value of 45 BPN when tested according to ASTM E303. Values for the Retroreflectivity Level I material with a raised surface pattern as defined in ASTM D4505 are calculated by averaging values taken at downweb and at a 45 degrees angle from downweb.

(d) Retroreflective Requirements: The preformed plastic pavement marking tape shall have the minimum initial specific luminance values shown in Table 1015-7 when measured in accordance with ASTM D 4061.

Table 1015-7

Specific Luminance (mcd/sq m/lx)	Entrance		Observation Angle, degrees	Type
	White	Yellow		
300	500	88.76	1.05	Retroreflectivity Level I
250	375	88.76	1.05	DOTD Intersection Grade
175	250	88.76	1.05	Retroreflectivity Level II

(e) Durability Requirements: The DOTD Intersection Grade preformed plastic pavement marking tape shall show no appreciable fading, lifting or shrinkage for a least 12 months after placement when placed in accordance with the manufacturer's recommended procedures on pavement surfaces having a daily traffic count not to exceed 15,000 ADT per lane. The Retroreflectivity Level I preformed plastic pavement marking tape shall show no appreciable fading, lifting or shrinkage for a least 4 years after placement for longitudinal lines and at least 2 years after placement for symbols and legends. The Retroreflectivity Level I preformed plastic pavement marking tape shall also retain the following reflectance values for the time period detailed in Table 1015-8.

Table 1015-8

Retained Specific Luminance for Retroreflectivity Level I
Preformed Plastic Pavement Marking Tape

Specific Luminance (mcd/sq m/lx)	Entrance		Observation Angle, degrees	Time
	White	Yellow		
100	400	88.76	1.05	1 year
100	100	88.76	1.05	4 years (2 years for symbols and legend)

(f) Plastic Pavement Marking Tape Guaranty (DOTD Intersection Grade and Retroreflectivity Level I): If the plastic pavement marking tape fails to comply with the performance and durability requirements of this subsection within 12 months for DOTD Intersection Grade and 4 years for Retroreflectivity Level I, the manufacturer shall replace the plastic pavement marking material at no cost to the Department.

SECTION 1020 – TRAFFIC SIGNALS:

Subsection 1020.01 – Traffic Signal Heads (06/07), Pages 873 – 884.

Delete the contents of Heading (a), General Requirements and substitute the following.

(a) General Requirements: Traffic signal sections, beacon sections and pedestrian signal sections shall be of the adjustable type. Materials and construction of each section shall be the same.

Signals shall be constructed for either 8 or 12-inch (200 mm or 300 mm) lens in accordance with the plans. Signal sections shall have three to five sections per face and beacon sections have only one section per face. Signal sections and associated brackets shall be finished inside and out with two coats of high grade dark olive green enamel, color number 14056 according to Federal Standard No. 595b with each coat independently baked. Visors shall be coated green on the outside and black on the inside. Edges shall be deburred and smooth with no sharp edges.

Subsection 1020.04 – Poles for Traffic Signal Systems (06/07), Pages 890 – 894.

Delete the sixth paragraph of Heading (a), Pedestal Support Signal Poles, and substitute the following.

Pedestals shall be finished with at least one coat of rustproofing primer, applied to a clean surface and one coat of dark olive green enamel, color number 14056 according to Federal Standard No. 595.

STANDARD PLANS TO
BE USED ON THIS PROJECT

STANDARD REV. DATE
PM-01 01-21-98

STATE OF LOUISIANA
DEPARTMENT OF TRANSPORTATION

PLANS OF PROPOSED
STATE HIGHWAY

STATE PROJECT NO. 337-04-0011
WEST CARROLL PARISH LINE - JCT. LA 577
EAST CARROLL PARISH
LA 877

C.S. LOG MILE 0.100
STA. 10+00
BEG. S.P. 337-04-0011

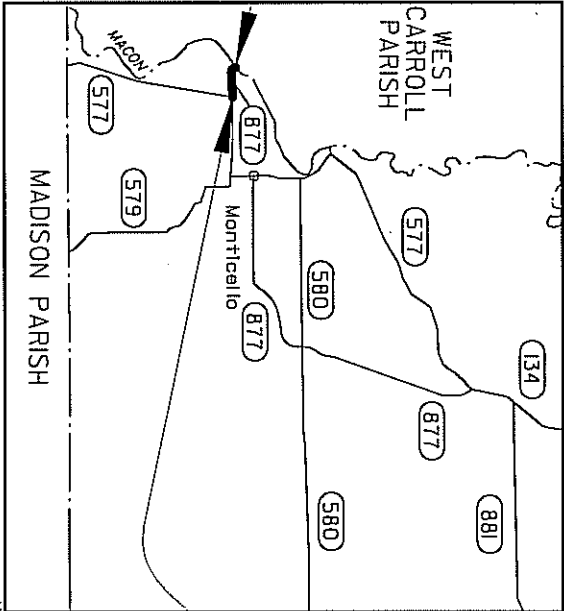

C.S. LOG MILE 0.710
STA. 42+20
END. S.P. 337-04-0011

TRAFFIC DATA
2009 A.D.T. = 375
2019 A.D.T. = 400
D = 55%
K = 10%
T = 12%

TYPE OF CONSTRUCTION: ASPHALT SURFACE TREATMENT

DATE	REVISIONS	DATE	RECOMMENDED	DATE	APPROVED

THE 2006 LOUISIANA DOTD STANDARD SPECIFICATIONS
FOR ROADS AND BRIDGES, AS AMENDED BY THE PROJECT
SPECIFICATIONS, SHALL GOVERN ON THIS PROJECT.

RECOMMENDED FOR APPROVAL

PROGRAM DELIVERY/DESIGN ENGINEER

[Signature]
DISTRICT ADMINISTRATOR

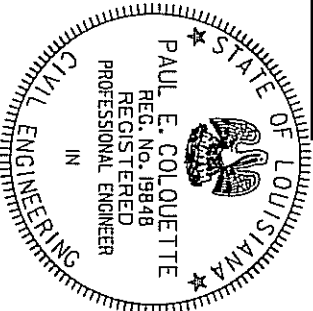

TITLE SHEET

DESIGNED CHECKED	R.E.C. D.E.P.	PARISH	EAST CARROLL
DETAILED CHECKED	M.R.P. D.E.P.	FEDERAL PROJECT	
DATE SHEET	AUGUST 09	STATE PROJECT	337-04-0011

NO.	DATE	REVISION DESCRIPTION	BY

INDEX TO SHEETS

- 1 TITLE SHEET
- 2 INDEX TO SHEETS
- 3 LIMITS OF PROJECT
- 4 TYPICAL SECTIONS & DETAILS
- 5 SURFACING SHEET
- 6 SUMMARY OF ESTIMATED QUANTITIES
- 7-10 TRAFFIC CONTROL & SIGNING DETAILS

DESIGNED		P.E.C.	PARISH	EAST CARROLL	SHEET NUMBER
CHECKED		D.E.P.			
DETAILED		M.R.P.	FEDERAL	PROJECT	
CHECKED		D.E.P.			
DATE	AUGUST 09	STATE	337-04-0011		2
SHEET					

INDEX TO SHEETS

NO.	DATE	REVISION DESCRIPTION	BY

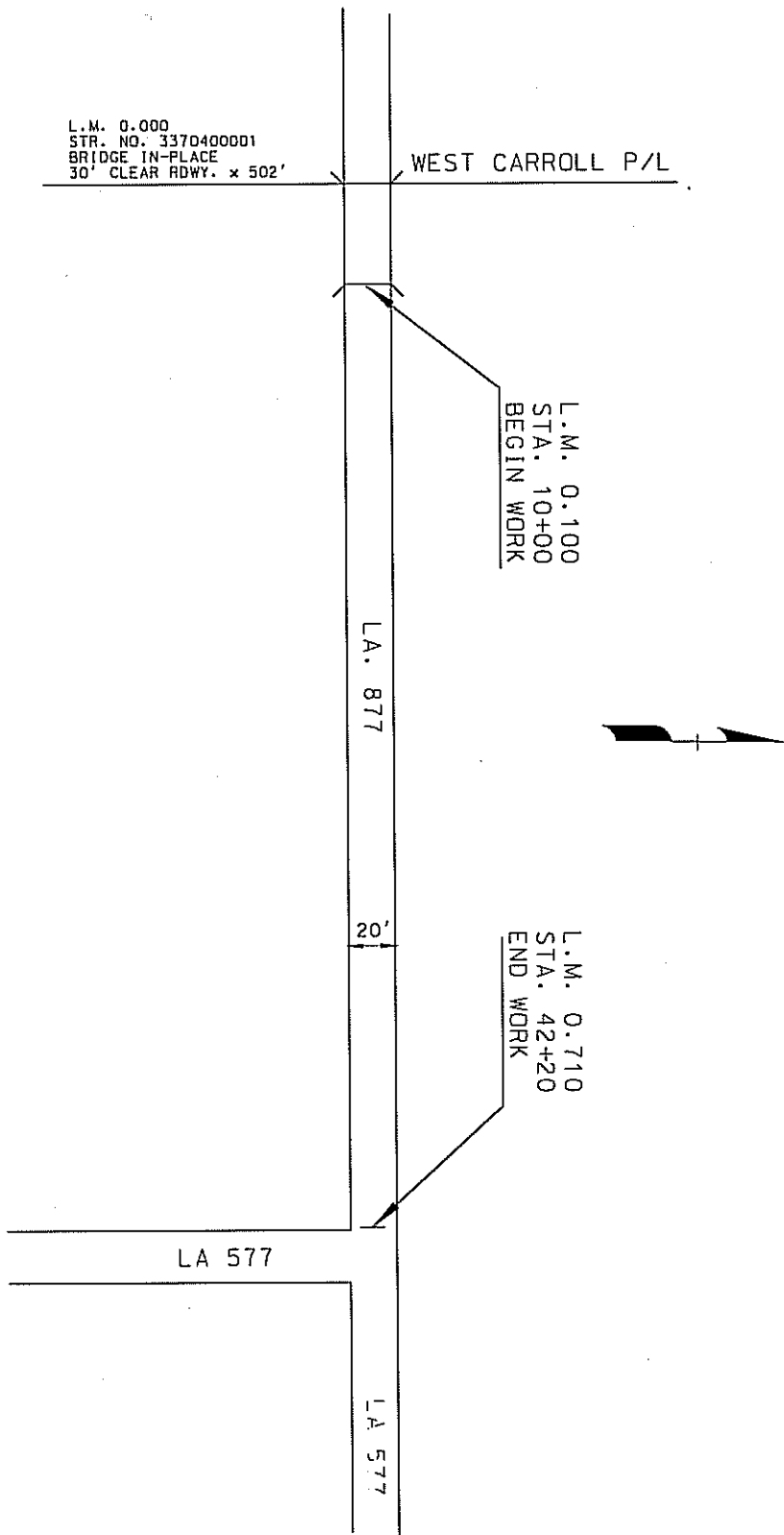

DESIGNED CHECKED			P.E.C. O.E.P.		PARISH EAST CARROLL		SHEET NUMBER 3
DETAILED CHECKED			M.R.P. O.E.P.		FEDERAL PROJECT		
DATE SHEET			AUGUST 09		STATE PROJECT 337-04-0011		
NO.	DATE	REVISION DESCRIPTION	LIMITS OF PROJECT			B7	

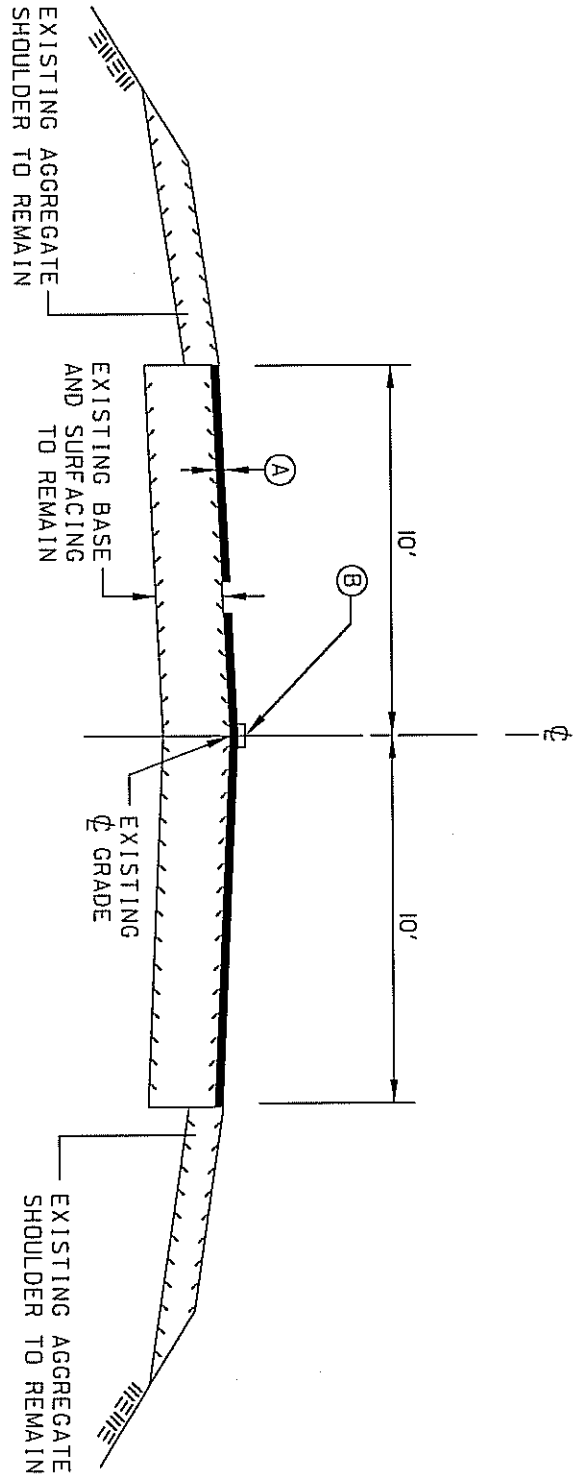

TYPICAL SECTION

TO APPLY: STA. 10+00 TO STA. 42+20

- (A) ASPHALTIC SURFACE TREATMENT (TYPE C) (2 APPLICATIONS)
- (B) PAINTED CENTERLINE STRIPING

- NOTES: 1) BEGINNING ON THE DAY FOLLOWING THE APPLICATION OF ANY PORTION OF ASPHALTIC SURFACE TREATMENT, THAT PORTION SHALL BE SWEEPED OR BLOWN AS DIRECTED BY THE PROJECT ENGINEER TO REMOVE LOOSE AGGREGATES EVERY DAY FOR FOUR (4) CONSECUTIVE DAYS.
- 2) AGGREGATE SHALL CONSIST OF CRUSHED STONE ONLY.
- 3) THE CONTRACTOR IS TO PLACE LOOSE GRAVEL SIGNS AT BOTH ENDS OF THE PROJECT AND AT EVERY HALF OF A MILE ON BOTH SIDES OF ROADWAY THROUGHOUT THE PROJECT. TO BE PAID FOR UNDER ITEM 713-01-00100.

DESIGNED		P.E.C.	PARISH	EAST CARROLL
CHECKED		D.E.P.	FEDERAL PROJECT	
DATE		AUGUST 09	STATE PROJECT	337-04-0011
REVISION DESCRIPTION		TYPICAL SECTION		
NO.	DATE	BY	SHEET NUMBER 4	

ROADWAY SURFACING

STATION	STATION	DESCRIPTION	LENGTH		WIDTH		SQ. YDS.	ASPHALTIC MATERIAL (CRS-2P EMULSION)	GAL.	AGGREGATE (S2)	SQ. YD.	AGGREGATE (S3)	SQ. YD.		
			FEET	FEET	FEET	FEET									
10+00	42+20	ROADWAY	3,220		20		7,156	4,866		7,156		7,156			
TOTALS													4,866	7,156	7,156

SURFACING SHEET				DESIGNED: P.E.C.	P.A.R.I.S.H.	EAST CARROLL	SHEET NUMBER 5	
				CHECKED: O.E.P.	FEDERAL PROJECT			
				DATE: AUGUST 09	STATE PROJECT	337-04-0011		
NO.	DATE	REVISION DESCRIPTION	BY					



Summary Of Estimated Quantities

Proposal ID: 337-04-0011 State Project Number:

Federal Project Number:

Proposal Description: WEST CARROLL PARISH LINE - JCT LA 577

Item No.	Description	Supplemental Description	Alternate Set Member	Quantity	Units
	General Items				
507-01-00100	Asphaltic Material (CRS-2P Emulsion)			4,866,000	GAL
507-02-00200	Aggregate (S2)			7,156,000	SCYD
507-02-00300	Aggregate (S3)			7,156,000	SCYD
713-01-00100	Temporary Signs and Barricades			1,000	LUMP
713-03-02000	Temporary Pavement Markings (Broken Line) (4" Width) (10' Length)			1,056	MILE
713-04-01000	Temporary Pavement Markings (Solid Line) (4" Width)			0,900	MILE
713-06-00200	Temporary ReflectORIZED Raised Pavement Markers (Tabs)			162,000	EACH
727-01-00100	Mobilization			1,000	LUMP
731-02-00100	ReflectORIZED Raised Pavement Markers			81,000	EACH
737-01-00100	Painted Traffic Striping (Solid Line) (4" Width)			0,450	MILE
737-02-00100	Painted Traffic Striping (Broken Line) (4" Width)			0,528	MILE
740-01-00100	Construction Layout			1,000	LUMP

Notes:

Empty box for notes.

2-1

GENERAL PROVISIONS

- Temporary Traffic Control (TTC) devices used shall be in accordance with the LDOT Standard Specifications for Road and Signs, the Manual on Uniform Traffic Control Devices (MUTCD), and shall meet the National Cooperative Highway Research Program (NCHRP) 350 for Test Level 3 requirements.
- Materials used for Temporary Traffic Control shall be in accordance with the LDOT Standard Specifications for Road and Signs and when applicable the LDOT Qualified Products List (QPL).
- No temporary traffic control shall be erected without the approval of the Project Engineer and until work is about to begin, unless they are covered.
- No temporary traffic control shall be erected without the approval of the Project Engineer for the installation, erection, and operation for in these plans or otherwise, unless they are covered.
- Responsibility for the erection of temporary traffic control shall be the responsibility of the contractor for the installation, erection, and operation for in these plans or otherwise, unless they are covered.
- The contractor shall also be responsible for the maintenance of all permanent signs and pavement markings left in place as essential to the safe movement and guidance of traffic within the project limits.
- The District Traffic Operations Engineer (DTOE) shall serve as a technical advisor to the Project Engineer for all Traffic Control matters.
- Road Work Heat XX Miles* sign shall be required on all projects equal to or greater than 2 miles and located at the beginning of the project unless otherwise noted. The distance on the sign shall be stated to the nearest whole mile. The sign shall be a minimum 36" X 60" unless otherwise noted.
- Warning signs used for lane closures or lane shifts in which the roadway shall be reduced to the public use within 12 hours or less may be placed on NCHRP 350 approved portable sign frames.
- The spacing on the plans need to be altered, the new spacings need to be approved by the Project Engineer.

SPEED LIMITS

- Speed limits shall be lowered by 10 mph for any construction, maintenance or utility operation that requires one or more of the following:
 - (A) The condition of the original highway is degraded due to milled surfaces or uneven pavements;
 - (B) Work is in progress in the immediate vicinity of the travel way requiring lane closures, lane width reductions, or low speed diversions; (C) workers present on the shoulder within 2' of the edge of traveled way;
 - (D) The reduced speed zone shall apply to those portions of the roadway that are affected. The Project Engineer shall determine the extent of the reduced speed zone.
- At the end of the reduced speed zone, a speed limit sign displaying the original speed limit before construction shall be installed.
- If conditions warrant, the District Traffic Operations Engineer may authorize the reduction of the speed limit by more than 10 mph.

PAVEMENT MARKINGS (see QPL)

- All pavement markings within the limits of the project shall be in conformance with the Manual on Uniform Traffic Control Devices (MUTCD) and shall be installed in accordance with the LDOT Standard Specifications for Road and Signs. The Project Engineer shall be responsible for the installation, erection, and operation for in these plans or otherwise, unless they are covered.
- Temporary Traffic Control Markers (TTM) may be used to supplement permanent pavement markings. TTM shall be installed in accordance with the LDOT Standard Specifications for Road and Signs. The Project Engineer shall be responsible for the installation, erection, and operation for in these plans or otherwise, unless they are covered.
- Temporary Traffic Control Markers (TTM) shall be used to supplement permanent pavement markings. TTM shall be installed in accordance with the LDOT Standard Specifications for Road and Signs. The Project Engineer shall be responsible for the installation, erection, and operation for in these plans or otherwise, unless they are covered.
- Temporary Traffic Control Markers (TTM) shall be used to supplement permanent pavement markings. TTM shall be installed in accordance with the LDOT Standard Specifications for Road and Signs. The Project Engineer shall be responsible for the installation, erection, and operation for in these plans or otherwise, unless they are covered.

SIGNS

- All signs used for temporary traffic control shall follow the Department of Transportation (DOT) Manual on Uniform Traffic Control Devices (MUTCD) and shall be installed in accordance with the LDOT Standard Specifications for Road and Signs. The Project Engineer shall be responsible for the installation, erection, and operation for in these plans or otherwise, unless they are covered.
- Signs shall be installed in accordance with the LDOT Standard Specifications for Road and Signs. The Project Engineer shall be responsible for the installation, erection, and operation for in these plans or otherwise, unless they are covered.
- Signs shall be installed in accordance with the LDOT Standard Specifications for Road and Signs. The Project Engineer shall be responsible for the installation, erection, and operation for in these plans or otherwise, unless they are covered.
- Signs shall be installed in accordance with the LDOT Standard Specifications for Road and Signs. The Project Engineer shall be responsible for the installation, erection, and operation for in these plans or otherwise, unless they are covered.

PORTABLE CHANGEABLE MESSAGE SIGNS

- When working within the traveled way, including shoulders and quality lanes, Changeable Message Signs (CMS) shall be used on all freeways and on all other roadways having a posted speed limit of 40 mph or greater. CMS shall be used in accordance with the LDOT Standard Specifications for Road and Signs. The Project Engineer shall be responsible for the installation, erection, and operation for in these plans or otherwise, unless they are covered.
- CMS shall be used in accordance with the LDOT Standard Specifications for Road and Signs. The Project Engineer shall be responsible for the installation, erection, and operation for in these plans or otherwise, unless they are covered.
- CMS shall be used in accordance with the LDOT Standard Specifications for Road and Signs. The Project Engineer shall be responsible for the installation, erection, and operation for in these plans or otherwise, unless they are covered.

FLASHERS

- Flashers shall be used on all freeways, on all other roadways having a posted speed limit of 40 mph or greater, and on all other roadways having a posted speed limit of 40 mph or greater. Flashers shall be used in accordance with the LDOT Standard Specifications for Road and Signs. The Project Engineer shall be responsible for the installation, erection, and operation for in these plans or otherwise, unless they are covered.
- Flashers shall be used in accordance with the LDOT Standard Specifications for Road and Signs. The Project Engineer shall be responsible for the installation, erection, and operation for in these plans or otherwise, unless they are covered.
- Flashers shall be used in accordance with the LDOT Standard Specifications for Road and Signs. The Project Engineer shall be responsible for the installation, erection, and operation for in these plans or otherwise, unless they are covered.

FLASHING ARROW PANELS

- Flashing Arrow Panels shall be used for lane closures on all freeways, on all other roadways having a posted speed limit of 40 mph or greater, and on all other roadways having a posted speed limit of 40 mph or greater. Flashing Arrow Panels shall be used in accordance with the LDOT Standard Specifications for Road and Signs. The Project Engineer shall be responsible for the installation, erection, and operation for in these plans or otherwise, unless they are covered.
- Flashing Arrow Panels shall be used in accordance with the LDOT Standard Specifications for Road and Signs. The Project Engineer shall be responsible for the installation, erection, and operation for in these plans or otherwise, unless they are covered.
- Flashing Arrow Panels shall be used in accordance with the LDOT Standard Specifications for Road and Signs. The Project Engineer shall be responsible for the installation, erection, and operation for in these plans or otherwise, unless they are covered.

FLASHING LIGHTS

- Flashing lights shall be used for lane closures on all freeways, on all other roadways having a posted speed limit of 40 mph or greater, and on all other roadways having a posted speed limit of 40 mph or greater. Flashing lights shall be used in accordance with the LDOT Standard Specifications for Road and Signs. The Project Engineer shall be responsible for the installation, erection, and operation for in these plans or otherwise, unless they are covered.
- Flashing lights shall be used in accordance with the LDOT Standard Specifications for Road and Signs. The Project Engineer shall be responsible for the installation, erection, and operation for in these plans or otherwise, unless they are covered.
- Flashing lights shall be used in accordance with the LDOT Standard Specifications for Road and Signs. The Project Engineer shall be responsible for the installation, erection, and operation for in these plans or otherwise, unless they are covered.

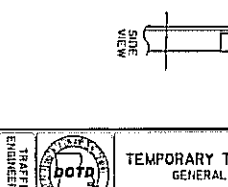
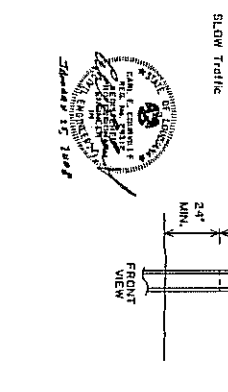
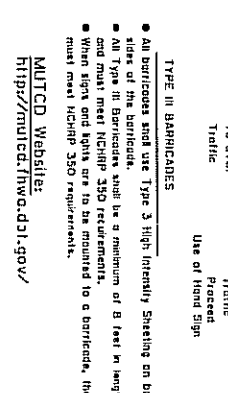
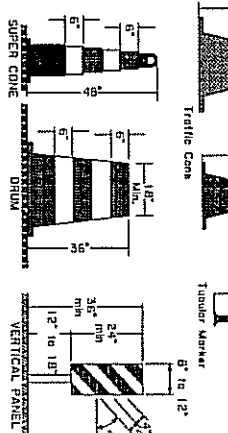

MUTCD Websites: <http://mutcd.fhwa.dot.gov/>

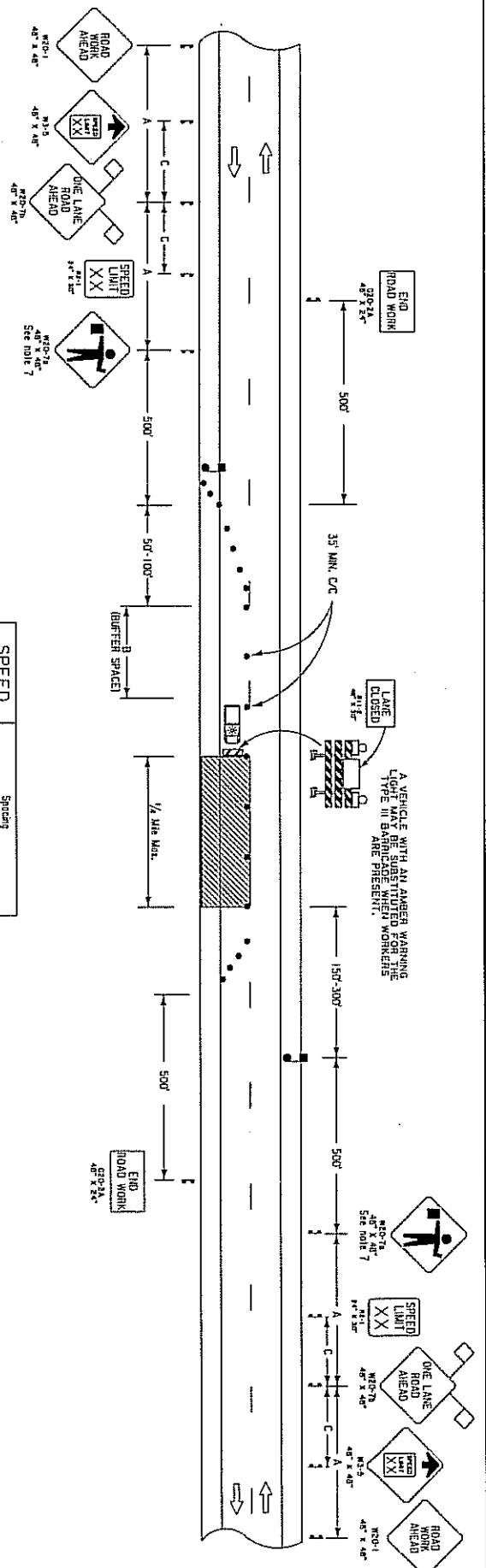

SPEED LIMIT	Spacing		
	"A"	"B"	"C"
35 mph (See note 5)	500'	250'	N/A
45 mph	1000'	360'	500'
55 mph	1500'	450'	800'

SPACING TO BE ADJUSTED FOR HORIZONTAL & VERTICAL CURVES.

- LEGEND**
- ↑ Traffic Sign
 - ⚠ Flagger
 - Channelizing Devices
 - ▨ Type III Barricades
 - ▩ Work Area
 - ⚡ Type B Light

- NOTES**
- THIS SHEET SHALL BE USED WITH THE TEMPORARY TRAFFIC CONTROL GENERAL NOTES SHEET TTC-001.
1. CONDITIONS REPRESENTED ARE FOR WORK WHICH REQUIRES CLOSING TRAFFIC LANES DURING DAYLIGHT HOURS OR X PORTABLE SIGNS MAY BE USED FOR WORK LASTING LESS THAN 3 DAYS.
 2. WHEN A WORK AREA HAS BEEN ESTABLISHED ON ONE SIDE OF THE ROADWAY ONLY, THERE SHALL BE NO PARKING ON THE OPPOSITE SHOULDER WITHIN 500 FEET OF THE WORK AREA.
 3. CHANNELIZING DEVICES MAY BE PLACED UP TO 2' BEYOND CENTERLINE ONLY AT SPECIFIC LOCATIONS WHERE ACTUAL WORK ACTIVITY IS TAKING PLACE. AT A MINIMUM TRAVELED LANE SHOULD BE MAINTAINED WHERE PRACTICAL. CHANNELIZING DEVICES SHALL BE RETURNED TO THE CENTERLINE WHEN THE WORK ACTIVITY HAS PASSED.
 4. SPACING OF CHANNELIZING DEVICES IN THE TAPER SHOULD BE NO MORE THAN 20'. A MINIMUM OF 5 CHANNELIZING DEVICES ARE TO BE USED IN THE TAPER.
 5. SPEED LIMIT REFERS TO THE LEGALLY ESTABLISHED SPEED LIMIT BEFORE CONSTRUCTION.
 6. TO PREVENT VEHICLES FROM ENTERING THE WORK AREA AGAINST THE FLOW OF TRAFFIC, AN ADDITIONAL FLAGGER SHALL BE STATIONED AT EACH INTERSECTION, MAJOR DRIVEWAY, RAILROAD CROSSING OR CROSSING WITHIN THE WORK AREA.
 7. VISUAL OR RADIO CONTACT SHALL BE REQUIRED BETWEEN FLAGGERS AT ALL TIMES. THE FLAGGER SHALL BE VISIBLE FROM FLAGGER SIGN.

8. ANY SIGNS IN CONFLICT WITH CONSTRUCTION SIGNING SHALL BE REMOVED OR COVERED BY THE CONTRACTOR.
9. MINIMUM CONSTRUCTION SIGNING, ANY ADDITIONAL SIGNS SHOWN IN THE MANUAL OR UNIFORM TRAFFIC CONTROL DEVICES AND REQUIRED BY THE PROJECT ENGINEER SHALL BE INSTALLED UNDER ITEM 715.01.
10. TYPE III BARRICADES SHALL BE PLACED IN THE CLOSED LANE AT A 90° ANGLE TO THE TRAVEL DIRECTION. TYPE III BARRICADES ARE ALSO REQUIRED BEFORE EACH OR GROUP OF UNFILLED HOLES OR HOLES FILLED WITH TEMPORARY MATERIAL OR WHERE UNCURED CONCRETE EXISTS.
11. NEITHER WORK ACTIVITY NOR STORAGE OF EQUIPMENT, VEHICLES, OR MATERIALS SHALL OCCUR WITHIN THE BUFFER SPACE.



	TRAFFIC CONTROL LAYOUT FOR LANE CLOSURE LESS THAN 1/4 MILE IN LENGTH			SECTION: E COURVILLE	PART: EAST CARROLL
	DRAWN BY: J. COLVIN	CHECKED BY: J. COLVIN		DATE: 01/25/2008	PROJECT: FEDERAL
PROJECT NO: 337-04-001	SHEET NO: 1	TOTAL SHEETS: 2	DATE: 01/25/2008	PROJECT: FEDERAL	SHEET NO: 1

- * REMOVE OR COVER WHEN NO LONGER APPLICABLE.
- * REPLACE WITH ROAD WORK 1/2 MILE* WHEN NO LONGER APPLICABLE.

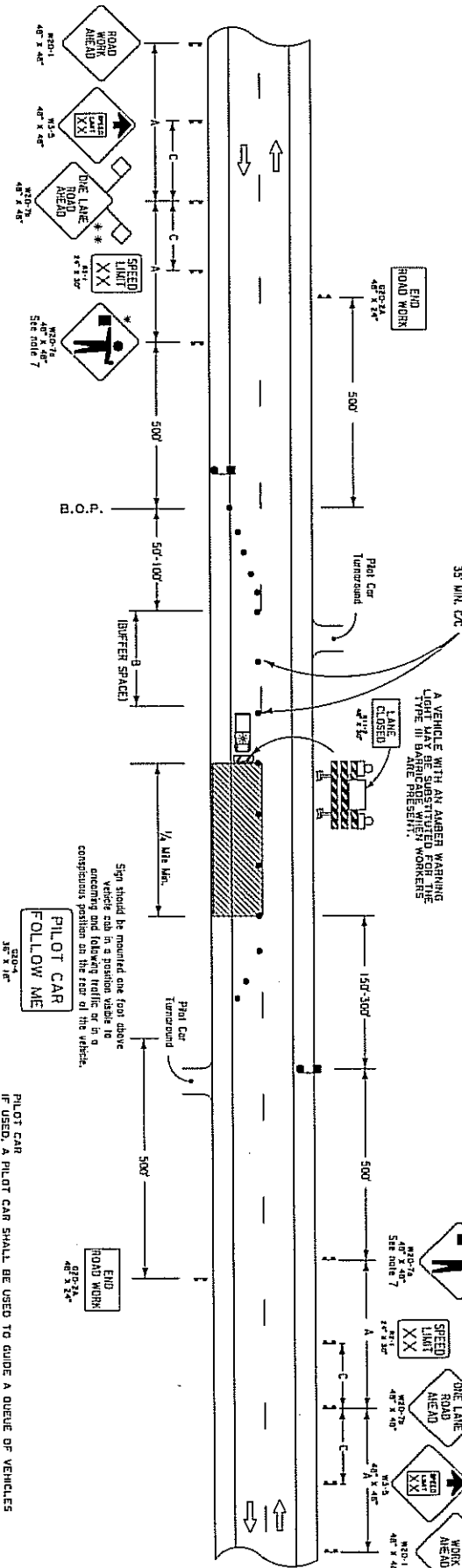

NOTES

1. WHEN A WORK AREA HAS BEEN ESTABLISHED ON ONE SIDE OF THE ROADWAY TRAFFIC CONTROL DEVICES SHALL BE PLACED ON THE OPPOSITE SHOULDER WITHIN 500 FEET OF THE WORK AREA.
2. CHANNELIZING DEVICES MAY BE PLACED UP TO 2' BEYOND CENTERLINE ONLY AT SPECIFIC LOCATIONS WHERE ACTUAL WORK ACTIVITY IS TAKING PLACE. A 10' MINIMUM TRAVELED LANE SHOULD BE MAINTAINED WHERE PRACTICAL. CHANNELIZING DEVICES SHALL BE RETURNED TO THE CENTERLINE WHEN THE WORK ACTIVITY HAS PASSED.
3. SPACING OF CHANNELIZING DEVICES IN THE TAPER SHOULD BE NO MORE THAN 20'. A MINIMUM OF 5 CHANNELIZING DEVICES ARE TO BE USED IN THE TAPER.
4. SPEED LIMIT REFERS TO THE LEGALLY ESTABLISHED SPEED LIMIT BEFORE CONSTRUCTION.
5. TO PREVENT VEHICLES FROM ENTERING THE WORK AREA AGAINST THE FLOW OF TRAFFIC, AN ADDITIONAL FLAGGER SHALL BE STATIONED AT EACH INTERSECTION, MAJOR DRIVEWAY, RAILROAD CROSSING OR CROSSING WITHIN THE WORK AREA.
6. WITH THE APPROVAL OF THE ENGINEER, THE LENGTH OF THE WORK AREA MAY FOR A SHORT DURATION, BE CHANGED TO AS MUCH AS ONE-HALF MILE MAXIMUM TO IMPROVE THE SIGHT DISTANCE TO THE FLAGGERS. VISUAL OR RADIO CONTACT SHALL BE REQUIRED BETWEEN THE FLAGGERS AT ALL TIMES.
7. FOR PROJECTS IN RURAL AREAS THE DISTANCE BETWEEN FLAGGERS SHALL NOT EXCEED 2.5 MILES FOR A.D.T. (AVERAGE DAILY TRAFFIC) OF LESS THAN 2,500 AND 2.0 MILES FOR A.D.T. FROM 2,500 TO 5,000. DISTANCE BETWEEN FLAGGERS SHALL NOT EXCEED 1.5 MILES FOR A.D.T. GREATER THAN 5,000 VEHICLES.

LEGEND

1. ANY SIGN IN CONTACT WITH CONSTRUCTION SIGNING SHALL BE REMOVED OR COVERED.
2. MINIMUM CONSTRUCTION SIGNING ANY ADDITIONAL SIGNS SHOWN IN THIS SHEET SHALL BE PLACED IN ACCORDANCE WITH THE REQUIREMENTS OF THE PROJECT ENGINEER SHALL BE INSTALLED UNDER ITEM 713-01.
3. VISUAL OR RADIO CONTACT SHALL BE REQUIRED BETWEEN FLAGGERS AT ALL TIMES. THE FLAGGER SHALL BE VISIBLE FROM FLAGGER SIGN.
4. TYPE II BARRICADES SHALL BE PLACED IN THE CLOSED LANE AT A 1000' INTERVAL WHEN NO ACTIVE WORK IS OCCURRING. TYPE III BARRICADES OF UNFILLED HOLES OR HOLES FILLED WITH TEMPORARY MATERIAL, OR WHERE UNCURED CONCRETE EXISTS.
5. THE CONTRACTOR CAN USE EITHER A PILOT CAR OR CHANNELIZING DEVICES IN THE TANGENT SECTION. IF A PILOT CAR IS REQUIRED THEN THE TANGENT SECTION.
6. NEITHER WORK ACTIVITY NOR STAGE OF EQUIPMENT, VEHICLES, OR MATERIALS SHALL OCCUR WITHIN THE BUFFER SPACE.

SPEED LIMIT	Spacing		
	'A'	'B'	'C'
(See note 4)	1/2	1/2	1/2
35 mph	500'	250'	150'
45 mph	1000'	350'	200'
55 mph	1500'	495'	300'

TRAFFIC CONTROL LAYOUT FOR LANE CLOSURE GREATER THAN 1/2 MILE (SUITABLE FOR MOVING OPERATIONS)

TC-03

PROJECT NO.	337-04-001
DATE	01/25/2008
DESIGNED BY	J. COLVIN
CHECKED BY	J. COLVIN
DATE	01/25/2008
PROJECT	EAST CARROLL

STATE PROJECT NO. 337-04-0011 (CM)
WEST CARROLL PARISH LINE - JCT LA 577
LA 877
EAST CARROLL PARISH

CONSTRUCTION PROPOSAL
INFORMATION
FOR



STATE OF LOUISIANA
DEPARTMENT OF TRANSPORTATION AND
DEVELOPMENT

To receive a copy of the contract and subsequent correspondence / communication from LA DOTD, with respect to the bid bonds, the following information must be provided:

_____ Bonding Agency or Company Name
 _____ Address
 _____ Agent or Representative
 _____ Phone Number / Fax Number

 Typed or Printed Name

_____ Agent or Attorney-in-Fact

 (Seal)
 By
 _____ Surety

_____ Typed or Printed Name
 _____ Authorized Officer-Owner-Partner
 By _____
 _____ Principal (Bidder or First Partner to Joint Venture)

_____ Typed or Printed Name
 _____ Authorized Officer-Owner-Partner
 By _____
 _____ If a Joint Venture, Second Partner

The condition of this obligation is such that, whereas the Principal has submitted a bid to the Department on a contract for the construction of **STATE PROJECT NO. 337-04-0011, WEST CARROLL PARISH LINE - JCT LA 577, ROUTE LA 877, EAST CARROLL PARISH**, if the bid is accepted and the Principal, within the specified time, enters into the contract in writing and gives bond with Surety acceptable to the Department for payment and performance of said contract, this obligation shall be void; otherwise to remain in effect.

Signed and sealed this _____ day of _____, 20_____.

(Bidder) _____ as Principal and _____ as Surety, are bound unto the State of Louisiana, Department of Transportation and Development, (hereinafter called the Department) in the sum of five percent (5%) of the bidder's total bid amount as calculated by the Department for payment, of which the Principal and Surety bind themselves, their heirs, executors, administrators, successors and assigns, as solidary obligors.

A Bid Bond is required when the bidder's total bid amount as calculated by the Department in accordance with Subsection 103.01 is greater than \$50,000. (See Section 102 of the Project Specifications.)

BID BOND



8/3/2009

Louisiana Department of Transportation and Development
Proposal Schedule of Items
Page: 1

Contract ID: 337-04-0011
Project(s): 337-04-0011
SECTION: 1
GENERAL ITEMS

Proposal Line Number	Item ID	Description	Approximate Quantity	Unit	of Measure
----------------------	---------	-------------	----------------------	------	------------

0001	507-01-00100	Asphaltic Material (CRS-2P Emulsion)	4,866.000	GAL	
------	--------------	--------------------------------------	-----------	-----	--

0002	507-02-00200	Aggregate (S2)	7,156.000	SQYD	
------	--------------	----------------	-----------	------	--

0003	507-02-00300	Aggregate (S3)	7,156.000	SQYD	
------	--------------	----------------	-----------	------	--

0004	713-01-00100	Temporary Signs and Barricades	LUMP SUM		
------	--------------	--------------------------------	----------	--	--

0005	713-03-02000	Temporary Pavement Markings (Broken Line) (4" Width) (10' Length)	1.056	MILE	
------	--------------	-------------------------------------------------------------------	-------	------	--

0006	713-04-01000	Temporary Pavement Markings (Solid Line) (4" Width)	0.900	MILE	
------	--------------	-----------------------------------------------------	-------	------	--

0007	713-06-00200	Temporary Reflectized Raised Pavement Markers (Tabs)	162.000	EACH	
------	--------------	------------------------------------------------------	---------	------	--

0008	727-01-00100	Mobilization	LUMP SUM		
------	--------------	--------------	----------	--	--

Dollars _____
Cents _____



Louisiana Department of Transportation and Development

Proposal Schedule of Items

Contract ID: 337-04-0011 Project(s): 337-04-0011

SECTION: 1 GENERAL ITEMS

Proposal Line Number	Item ID	Description	Approximate Quantity	Unit	Unit Price (In Words, Ink or Typed)
----------------------	---------	-------------	----------------------	------	-------------------------------------

0009	731-02-00100	Reflectorized Raised Pavement Markers	81,000	EACH	
------	--------------	---------------------------------------	--------	------	--

0010	737-01-00100	Painted Traffic Striping (Solid Line) (4" Width)	0.450	MILE	
------	--------------	--------------------------------------------------	-------	------	--

0011	737-02-00100	Painted Traffic Striping (Broken Line) (4" Width)	0.528	MILE	
------	--------------	---------------------------------------------------	-------	------	--

0012	740-01-00100	Construction Layout	LUMP SUM		
------	--------------	---------------------	----------	--	--

Dollars _____
 Cents _____
 Dollars _____
 Cents _____

Section: 1 Total: _____

Total Bid: _____

CONSTRUCTION PROPOSAL SIGNATURE AND EXECUTION FORM

THIS FORM, THE SCHEDULE OF ITEMS, AND THE PROPOSAL GUARANTY MUST BE COMPLETED AS INDICATED AND SUBMITTED TO THE LOUISIANA DEPARTMENT OF TRANSPORTATION AND DEVELOPMENT (DOTD) TO CONSTITUTE A VALID BID

337-04-0011

STATE PROJECT NO(S):

FEDERAL AID PROJECT NO(S):

N/A

NAME OF PROJECT

WEST CARROLL PARISH LINE - JCT LA 577

I (WE) HEREBY CERTIFY THAT I (WE) HAVE CAREFULLY EXAMINED THE PROPOSAL, PLANS AND SPECIFICATIONS, INCLUDING ANY AND ALL ADDENDA, AND THE SITE OF THE ABOVE PROJECT AND AM (ARE) FULLY COGNIZANT OF ALL PROPOSAL DOCUMENTS, THE MASTER COPY OF WHICH IS ON FILE AT DOTD HEADQUARTERS IN BATON ROUGE, LA, AND ALL WORK, MATERIALS AND LABOR REQUIRED THEREIN, AND AGREE TO PERFORM ALL WORK, AND SUPPLY ALL NECESSARY MATERIALS AND LABOR REQUIRED FOR SUCCESSFUL AND TIMELY COMPLETION OF THE ABOVE PROJECT AND TO ACCEPT THE SUMMATION OF THE PRODUCTS OF THE UNIT PRICES BID ON THE SCHEDULE OF ITEMS ATTACHED HERETO AND MADE A PART HEREOF MULTIPLIED BY THE ACTUAL QUANTITY OF UNIT OF MEASURE PERFORMED FOR EACH ITEM, AS AUDITED BY DOTD, AS FULL AND FINAL PAYMENT FOR ALL WORK, LABOR AND MATERIALS NECESSARY TO COMPLETE THE ABOVE PROJECT, SUBJECT TO INCREASE ONLY FOR PLAN CHANGES (CHANGE ORDERS) APPROVED BY THE DOTD CHIEF ENGINEER OR HIS DESIGNEE. THIS BID IS SUBMITTED IN ACCORDANCE WITH THE GENERAL BIDDING REQUIREMENTS IN THE CONSTRUCTION PROPOSAL AND ALL SPECIAL PROVISIONS, PLANS, SUPPLEMENTAL SPECIFICATIONS, AND THE LOUISIANA STANDARD SPECIFICATIONS FOR ROADS AND BRIDGES (2006 EDITION), I (WE) UNDERSTAND THAT THE SUMMATION OF THE PRODUCTS OF THE UNIT PRICES BID ON THE SCHEDULE OF ITEMS MULTIPLIED BY THE ESTIMATED QUANTITY OF UNIT OF MEASURE FOR EACH ITEM, ALONG WITH ANY OTHER FACTOR SPECIFIED TO BE APPLICABLE SUCH AS CONSTRUCTION TIME AND/OR LANE RENTAL, SHALL BE THE BASIS FOR THE COMPARISON OF BIDS. I (WE) UNDERSTAND THAT THE SCHEDULE OF ITEMS MUST CONTAIN UNIT PRICES WRITTEN OUT IN WORDS AND THAT THE SCHEDULE OF ITEMS SUBMITTED AS PART OF THIS BID IS ON THE FORM SUPPLIED BY DOTD IN THE BID PROPOSAL. MY (OUR) PROPOSAL GUARANTY IN THE AMOUNT SPECIFIED FOR THE PROJECT IS ATTACHED HERETO AS EVIDENCE OF MY (OUR) GOOD FAITH TO BE FORFEITED IF THIS BID IS ACCEPTED BY DOTD AND I (WE) FAIL TO COMPLY WITH ANY REQUIREMENT NECESSARY FOR AWARD AND EXECUTION OF THE CONTRACT, AS WELL AS, SIGN AND DELIVER THE CONTRACT AND PAYMENT/PERFORMANCE/RETAINAGE BOND AS REQUIRED IN THE SPECIFICATIONS.

NONCOLLUSION DECLARATION (APPLICABLE TO FEDERAL-AID PROJECTS)

I (WE) DECLARE UNDER PENALTY OF PERJURY UNDER THE LAWS OF THE UNITED STATES AND THE STATE OF LOUISIANA THAT I (WE) HAVE NOT DIRECTLY OR INDIRECTLY, ENTERED INTO ANY AGREEMENT, PARTICIPATED IN ANY COLLUSION, OR OTHERWISE TAKEN ANY ACTION IN RESTRAINT OF FREE COMPETITIVE BIDDING IN CONNECTION WITH THE CONTRACT FOR THIS PROJECT NOR VIOLATED LA. R.S. 48:254.

BIDDERS DBE GOAL STATEMENT (APPLICABLE TO DBE GOAL PROJECTS)

IF THIS PROJECT IS DESIGNATED BY SPECIAL PROVISION AS A DISADVANTAGED BUSINESS ENTERPRISE (DBE) GOAL PROJECT IN ACCORDANCE WITH THE DBE PROVISIONS OF THIS CONTRACT, THE BIDDER ASSURES DOTD THAT HE/SHE WILL MEET OR EXCEED THE DBE CONTRACT GOAL, OR IF THE BIDDER CANNOT MEET THE REQUIRED DBE GOAL, THE BIDDER ASSURES DOTD THAT HE/SHE HAS MADE AND CAN DOCUMENT A GOOD FAITH EFFORTS MADE TOWARDS MEETING THE GOAL REQUIREMENT IN ACCORDANCE WITH THE CONTRACT AND DBE PROGRAM MANUAL INCORPORATED HEREIN BY REFERENCE.

THE APPARENT LOW BIDDER SHALL COMPLETE AND SUBMIT TO THE DOTD COMPLIANCE PROGRAMS OFFICE, FORM CS-6AAA AND ATTACHMENT) AND, IF NECESSARY, DOCUMENTATION OF GOOD FAITH EFFORTS MADE BY THE BIDDER TOWARD MEETING THE GOAL, WITHIN TEN BUSINESS DAYS AFTER THE OPENING OF BIDS FOR THIS PROJECT. RESPONSIVENESS OF INFORMATION SUPPLIED IN THIS SECTION OF THIS CONSTRUCTION PROPOSAL, SIGNATURE AND EXECUTION FORM IS GOVERNED BY THE DBE REQUIREMENTS INCLUDED WITHIN THE SPECIFICATIONS AND DBE PROGRAM MANUAL.

CERTIFICATION OF EMPLOYMENT OF LOUISIANA RESIDENTS TRANSPORTATION INFRASTRUCTURE MODEL FOR ECONOMIC DEVELOPMENT (TIME) PROJECTS (APPLICABLE TO TIME PROJECTS)

IF THIS PROJECT IS DESIGNATED BY SPECIAL PROVISION AS A TRANSPORTATION INFRASTRUCTURE MODEL FOR ECONOMIC DEVELOPMENT (TIME) PROJECT AS DEFINED IN ACT NO. 16 OF THE 1989 FIRST EXTRAORDINARY SESSION OF THE LEGISLATURE WHICH ENACTED PART V OF CHAPTER 7 OF SUBTITLE II OF TITLE 47 OF THE LOUISIANA REVISED STATUTES OF 1950, COMPRISED OF R.S. 47:820.1 THROUGH 820.6, THE BIDDER CERTIFIES THAT AT LEAST 80 PERCENT OF THE EMPLOYEES EMPLOYED ON THIS TIME PROJECT WILL BE LOUISIANA RESIDENTS IN ACCORDANCE WITH LOUISIANA R.S. 47:820.3.

NON PARTICIPATION IN PAYMENT ADJUSTMENT (ASPHALT CEMENT AND FUELS) STATEMENT

IF THIS PROJECT IS DESIGNATED BY SPECIAL PROVISION AS BEING SUBJECT TO PAYMENT ADJUSTMENT FOR ASPHALT CEMENT AND/OR FUELS, THE BIDDER HAS THE OPTION OF REQUESTING EXCLUSION FROM SAID PAYMENT ADJUSTMENT PROVISIONS THAT ARE ESTABLISHED BY SPECIAL PROVISION ELSEWHERE HEREIN.

IF THE BIDDER DESIRES TO BE EXCLUDED FROM THESE PAYMENT ADJUSTMENT PROVISIONS,

THE BIDDER IS REQUIRED TO MARK HERE

FAILURE TO MARK THIS BOX PRIOR TO BID OPENING WILL CONSTITUTE FORFEITURE OF THE BIDDER'S OPTION TO REQUEST EXCLUSION.

BIDDER SIGNATURE REQUIREMENTS (APPLICABLE TO ALL PROJECTS)

THIS BID FOR THE CAPTIONED PROJECT IS SUBMITTED BY:

Name of Principal (Individual, Firm, Corporation, or Joint Venture)

If Joint Venture, Name of First Partner

If Joint Venture, Name of Second Partner

(Louisiana Contractor's License Number of Bidder or First Partner to Joint Venture)

(Louisiana Contractor's License Number of Second Partner to Joint Venture)

(Business Street Address)

(Business Street Address)

(Business Mailing Address, if different)

(Business Mailing Address, if different)

(Area Code and Telephone Number of Business)

(Area Code and Telephone Number of Business)

(Telephone Number and Name of Contact Person)

(Telephone Number and Name of Contact Person)

(Telecopier Number, if any)

(Telecopier Number, if any)

ACTING ON BEHALF OF THE BIDDER, THIS IS TO ATTEST THAT THE UNDERSIGNED DULY AUTHORIZED REPRESENTATIVE OF THE ABOVE CAPTIONED FIRM, CORPORATION OR BUSINESS, BY SUBMISSION OF THIS BID, AGREES AND CERTIFIES THE TRUTH AND ACCURACY OF ALL PROVISIONS OF THIS PROPOSAL, INCLUSIVE OF THE REQUIREMENTS, STATEMENTS, DECLARATIONS AND CERTIFICATIONS ABOVE AND IN THE SCHEDULE OF ITEMS AND PROPOSAL GUARANTY. EXECUTION AND SIGNATURE OF THIS FORM AND SUBMISSION OF THE SCHEDULE OF ITEMS AND PROPOSAL GUARANTY SHALL CONSTITUTE AN IRREVOCABLE AND LEGALLY BINDING OFFER BY THE BIDDER.

(Signature) _____

(Printed Name) _____

(Title) _____

(Date of Signature) _____

CONTRACTOR'S TOTAL BASE BID \$ _____

IT IS AGREED THAT THIS TOTAL, DETERMINED BY THE BIDDER, IS FOR PURPOSES OF OPENING AND READING BIDS ONLY, AND THAT THE LOW BID FOR THIS PROJECT WILL BE DETERMINED FROM THE EXTENSION AND TOTAL OF THE BID ITEMS BY DOTD.

CS-14AA

08/06