

**STATE OF LOUISIANA  
DEPARTMENT OF TRANSPORTATION AND  
DEVELOPMENT**

**LETTER BID PROPOSAL**



**STATE PROJECT NO. 737-96-0076  
TREE AND STUMP REMOVAL IN DISTRICT 61  
DISTRICTWIDE**

**STATE PROJECT NO. 737-96-0076**  
**TABLE OF CONTENTS**

	Page No.
Title Sheet .....	A-1
Table of Contents .....	B-1
Notice to Contractors .....	C-1 thru C-2
Special Provisions .....	D-1 thru D-2
Supplemental Specifications:	
Supplemental Specifications for 2006 Standard Specifications (05/09) .....	E-1 thru E-36
Plans (30 sheets) .....	F-1 thru F-30
Construction Proposal Returnables:	
Title Sheet .....	G-1
Bid Bond .....	H-1
Schedule of Items .....	I-1
Construction Proposal Signature and Execution Form .....	J-1 thru J-2

## **NOTICE TO CONTRACTORS (08/07)**

Sealed paper bids for the following project will be received by the Department of Transportation and Development (DOTD). Paper bids can be delivered to the DOTD District 6 Headquarters Administration Building, 8100 Airline Highway, Room 4, Baton Rouge, Louisiana 70815 until 10:00 a.m. on **TUESDAY, JUNE 16, 2009**. Beginning at 10:00 a.m., all bids will be publicly opened and presented. The contractor's license number must appear on the bid envelope. No bids will be received after 10:00 a.m. or if the contractor's license number is not printed on the outside of the bid envelope. Any person requiring special accommodations shall notify DOTD at (225) 231-4100 not less than 3 business days before bid opening.

### **STATE PROJECT NO. 737-96-0076**

**DESCRIPTION: TREE AND STUMP REMOVAL IN DISTRICT 61**

**ROUTE: DISTRICTWIDE**

**PARISH: DISTRICTWIDE**

**ESTIMATED COST RANGE: \$50,000 - \$100,000**

**PROJECT ENGINEER: SELDERS, LAWANDA; 8100 Airline Hwy., Baton Rouge, LA 70815; (225) 231- 4117**

**PROJECT MANAGER: HAMMACK, TERRI; (225) 231-4102**

**COST OF PROPOSAL FORMS: FREE**

**COST OF PLANS: FREE Included in proposal (no additional charge)**

Bids must be prepared and submitted in accordance with Section 102 of the 2006 Louisiana Standard Specifications for Roads and Bridges as amended by the project specifications, and must include all information required by the proposal.

## **NOTICE TO CONTRACTORS (CONTINUED)**

Plans and specifications may be seen at the Project Engineer's office. Upon request, the Project Engineer will show the work.

The U. S. Department of Transportation (DOT) operates a toll free "Hotline" Monday through Friday, 8:00 a.m. to 5:00 p.m., eastern time. Anyone with knowledge of possible bid rigging, bidder collusion, or other fraudulent activities should call 1-800-424-9071. All information will be treated confidentially and caller anonymity will be respected.

**STATE PROJECT NO. 737-96-0076**  
**SPECIAL PROVISIONS**

**GENERAL BIDDING REQUIREMENTS (08/06):** The specifications, contract and bonds governing the construction of the work are the 2006 Edition of the Louisiana Standard Specifications for Roads and Bridges, together with any supplementary specifications and special provisions attached to this proposal.

Bids shall be prepared and submitted in accordance with Section 102 of the Standard Specifications.

The plans herein referred to are the plans approved and marked with the project number, route and Parish, together with all standard or special designs that may be included in such plans. The bidder declares that the only parties interested in this proposal as principals are those named herein; that this proposal is made without collusion or combination of any kind with any other person, firm, association, or corporation, or any member or officer thereof; that careful examination has been made of the site of the proposed work, the plans, Standard Specifications, supplementary specifications and special provisions above mentioned, and the form of contract and payment, performance, and retainage bond; that the bidder agrees, if this proposal is accepted, to provide all necessary machinery, tools, apparatus and other means of construction and will do all work and furnish all material specified in the contract, in the manner and time therein prescribed and in accordance with the requirements therein set forth; and agrees to accept as full compensation therefore, the amount of the summation of the products of the quantities of work and material incorporated in the completed project, as determined by the engineer, multiplied by the respective unit prices herein bid.

It is understood by the bidder that the quantities given in this proposal are a fair approximation of the amount of work to be done and that the sum of the products of the approximate quantities multiplied by the respective unit prices bid shall constitute gross sum bid, which sum shall be used in comparison of bids and awarding of the contract.

The bidder further agrees to perform all extra and force account work that may be required on the basis provided in the specifications.

The bidder further agrees that within 15 calendar days after the contract has been transmitted to him, he will execute the contract and furnish the Department satisfactory surety bonds.

If this proposal is accepted and the bidder fails to execute the contract and furnish bonds as above provided, the proposal guaranty shall become the property of the Department; otherwise, said proposal guaranty will be returned to the bidder; all in accordance with Subsection 103.04.

**MAINTENANCE OF TRAFFIC (11/13/08):** Subsection 104.03 of the 2006 Standard Specifications is amended to include the following requirements.

The contractor shall provide for and maintain through and local traffic at all times and shall conduct his operations in such manner as to cause the least possible interference with traffic at junctions with roads, streets and driveways.

Between October 1 and January 31, the contractor shall maintain the highway in a condition suitable for large scale sugar cane hauling operations and prior thereto shall perform only those items which will not interfere with the condition of the highway for heavy hauling operations. During this period, the contractor shall provide all equipment and material necessary to keep the highway in satisfactory condition. If the contractor does not properly maintain the highway, the Department reserves the right to maintain same with its own equipment, labor and material and deduct costs of such maintenance from payments for the work. If it becomes necessary to suspend construction operations for heavy hauling during the sugar cane season,

**STATE PROJECT NO. 737-96-0076**  
**SPECIAL PROVISIONS**

contract time will not be assessed for said period of suspension; however, maintenance of traffic shall be continued by the contractor during such period of suspension.

The roadway and shoulders shall remain open to traffic as much as possible during nonwork periods as directed by the engineer. During the period that all lanes are open to traffic, the contractor shall neither store material nor park equipment on roadway shoulders.

In East Baton Rouge Parish, the contractor will be required to work at night or on weekends in order to avoid significant traffic delays. All hours of work will be as directed by the Project Engineer.

**PROSECUTION OF WORK (12/08):** Subsection 108.04, Prosecution of Work of the Standard Specifications as amended by the supplemental specifications thereto, is further amended as follows.

**108.04 PROSECUTION OF WORK.**

Subpart (a), General is deleted and the following substituted.

(a) General: The contractor shall provide sufficient materials, equipment and labor to complete the project in accordance with the plans and specifications within the contract time. If the completed work is behind the approved progress schedule, the contractor shall take immediate steps to restore satisfactory progress and shall not transfer equipment or forces from uncompleted work without prior notice to, and approval of, the engineer. Each item of work shall be prosecuted to completion without delay. If prosecution of the work is discontinued for an extended period of time, the contractor shall give the engineer written notice at least 24 hours before resuming operations. The contractor's progress will be determined monthly at the time of each partial estimate, and will be based on the total amount earned by the contractor as reflected by the partial estimate. If the contractor's progress is behind more than 20 percent behind the elapsed contract time, the contractor may be notified that he is not prosecuting the work in an acceptable manner. If requested by the Department the contractor must meet with and provide the project engineer with an acceptable written plan which details how the contractor will re-gain lost progress and prosecute remaining work. If the contractor's progress is more than 30 percent behind the elapsed contract time, the contractor and the surety will be notified that he is not prosecuting the work in an acceptable manner. The contractor must meet with and provide the project engineer with an acceptable written plan which details how the contractor will re-gain lost progress and prosecute remaining work.

Subpart (b), Disqualification is deleted and the following substituted.

(b) Disqualification: A contractor who is in default in accordance with Subsection 108.09(a)(1) of and progress is deficient by 10 percent or more shall be immediately disqualified. The contractor shall remain disqualified until the project has received a final inspection and has been recommended for final acceptance. Should the surety or the Department take over prosecution of the work, the contractor shall remain disqualified for a period of one year from the completion of the project, unless debarment proceedings are instituted.

During the period of disqualification, the contractor will not be permitted to bid on contracts nor be approved as a subcontractor on contracts. Any bid submitted by the contractor during the period of disqualification will not be considered and will be returned.

**WORK HOUR AND LANE CLOSURE RESTRICTIONS:** All lanes shall remain open to traffic except during the times when lane closures are allowed. When closures are allowed, a

**STATE PROJECT NO. 737-96-0076**  
**SPECIAL PROVISIONS**

minimum of one lane per direction shall remain open to traffic at all times. Lane closures shall

only be allowed while work is being performed. All lane closures at any time shall be reviewed and approved by the Project Engineer.

For work being performed in East Baton Rouge Parish, allowable lane closures are as

follows:

Monday, Tuesday, Wednesday, Thursday, from 8:00 pm to 6:00 am the following day

Saturday from 6:00 am to 5:00 pm Sunday

Additional work periods may be allowed at the discretion of the project engineer. All closure lengths, times, locations, and durations shall be approved by the project engineer. A lane rental fee will be charged to the contractor for any lane closure on any roadway or ramp which extends beyond the allowable closure times. The number of lanes considered closed will be based on the number of lanes available prior to construction versus the number of lanes maintained during any particular hour.

No work shall be allowed, all lanes shall be open, and all time charges shall stop during the New Years, Mardi Gras, Easter, Memorial Day, Independence Day, Labor Day, Thanksgiving and Christmas holiday periods or during LSU and Southern home football game periods as defined by the Project Engineer.

<b>Unauthorized Lane Closure or Late Lane Opening Rental</b>	
<b>Current Average Daily Traffic (Vehicles per Day)</b>	<b>Hourly Rate (\$/Hour)</b>
<10,000	250
10,000 - 20,000	1,250
20,000 - 35,000	5,000
35,000 - 50,000	11,500
>50,000	15,000

**ITEMS S-001: Tree and Stump Removal (Under 36" – 36" Diameter):** These items consist of cutting and removal of trees and grinding of the remaining stumps as specified and directed.

Trees to be removed shall be as listed elsewhere in these specifications and shall be marked by the project engineer. Trees shall be removed without damaging other trees or items which are to remain. Damage to trees or items which are to remain shall be repaired or replaced by the contractor in accordance with Subsection 201.01 at no direct pay. A licensed arborists, as licensed by the State of Louisiana, shall be present at each location as work is being performed.

Trees shall be considered non-salvageable and shall be disposed of in accordance with Subsection 202.02.

Stumps shall be ground to minimum depth of 6 inches below the ground. The tree chips shall be removed in accordance with Subsection 201.02 and as directed. The remaining

**STATE PROJECT NO. 737-96-0076**  
**SPECIAL PROVISIONS**

hole shall be back filled with Useable Soils and compacted to the density of the surrounding ground as directed.

Any damage to existing slopes, embankments, ditches, or vegetation will be repaired by the contractor to the satisfaction of the engineer at no direct pay.

Measurement and payment for Tree and Stump Removal shall be at the contract unit price per each and shall include mobilization, signs & barricades, the cutting of the tree, disposal of the tree, grinding of the stump, and backfilling the remaining hole. The diameter will be measured 4' above natural ground.

Payment will be made under:

Item S-001, Tree and Stump Removal (Under 36" – 36" Diameter), Per each

**ITEM S-002: Tree and Stump Removal (Over 36" – 48" Diameter):** These items consist of cutting and removal of trees and grinding of the remaining stumps as specified and directed.

Trees to be removed shall be as listed elsewhere in these specifications and shall be marked by the project engineer. Trees shall be removed without damaging other trees or items which are to remain. Damage to trees or items which are to remain shall be repaired or replaced by the contractor in accordance with Subsection 201.01 at no direct pay. A licensed arborists, as licensed by the State of Louisiana, shall be present at each location as work is being performed.

Trees shall be considered non-salvageable and shall be disposed of in accordance with Subsection 202.02.

Stumps shall be ground to minimum depth of 6 inches below the ground. The tree chips shall be removed in accordance with Subsection 201.02 and as directed. The remaining hole shall be back filled with Useable Soils and compacted to the density of the surrounding ground as directed.

Any damage to existing slopes, embankments, ditches, or vegetation will be repaired by the contractor to the satisfaction of the engineer at no direct pay.

Measurement and payment for Tree and Stump Removal shall be at the contract unit price per each and shall include mobilization, signs & barricades, the cutting of the tree, disposal of the tree, grinding of the stump, and backfilling the remaining hole. The diameter will be measured 4' above natural ground.

Payment will be made under:

Item S-002, Tree and Stump Removal (Over 36" – 48" Diameter), Per each

**ITEMS S-003: Tree and Stump Removal (Over 48" Diameter):** These items consist of cutting and removal of trees and grinding of the remaining stumps as specified and directed.

Trees to be removed shall be as listed elsewhere in these specifications and shall be marked by the project engineer. Trees shall be removed without damaging other trees or items which are to remain. Damage to trees or items which are to remain shall be repaired or replaced by the contractor in accordance with Subsection 201.01 at no direct pay. A licensed arborists, as licensed by the State of Louisiana, shall be present at each location as work is being performed.

Trees shall be considered non-salvageable and shall be disposed of in accordance with Subsection 202.02.

Stumps shall be ground to minimum depth of 6 inches below the ground. The tree



**STATE PROJECT NO. 737-96-0076**  
**SPECIAL PROVISIONS**

chips shall be removed in accordance with Subsection 201.02 and as directed. The remaining hole shall be back filled with Useable Soils and compacted to the density of the surrounding ground as directed.

Any damage to existing slopes, embankments, ditches, or vegetation will be repaired by the contractor to the satisfaction of the engineer at no direct pay.

Measurement and payment for Tree and Stump Removal shall be at the contract unit price per each and shall include mobilization, signs & barricades, the cutting of the tree, disposal of the tree, grinding of the stump, and backfilling the remaining hole. The diameter will be measured 4' above natural ground.

Payment will be made under:

Item S-002, Tree and Stump Removal (Over 36" – 48" Diameter), Per each

**CONTRACT TIME (03/05):** The entire contract shall be completed in all details and ready for final acceptance in accordance with Subsection 105.17(b) within **FORTY FIVE (45) WORKING DAYS.**

**LOUISIANA**  
**DEPARTMENT OF TRANSPORTATION AND DEVELOPMENT**  
**SUPPLEMENTAL SPECIFICATIONS**  
(FOR 2006 STANDARD SPECIFICATIONS)

**TABLE OF CONTENTS**

**PART I – GENERAL PROVISIONS**

**SECTION 101 – GENERAL INFORMATION, DEFINITIONS, AND TERMS**  
Subsection 101.03 – Definitions .....1  
**SECTION 102 – BIDDING REQUIREMENTS**  
Subsection 102.09 – Proposal / Bid Guaranty .....1  
**SECTION 107 – LEGAL RELATIONS AND RESPONSIBILITY TO PUBLIC**  
Subsection 107.05 – Federal Aid Participation.....2  
**SECTION 108 – PROSECUTION AND PROGRESS**  
Subsection 108.04 – Prosecution of Work.....2

**PART II – EARTHWORK**

**SECTION 202 – REMOVING OR RELOCATING  
STRUCTURES AND OBSTRUCTIONS**  
Subsection 202.06 – Plugging or Relocating Existing Water Wells .....2

**PART III – BASE COURSES**

**SECTION 302 – CLASS II BASE COURSE**  
Subsection 302.01 – Description .....2  
Subsection 302.02 – Materials .....2  
Subsection 302.04 – General Construction Requirements .....2  
Subsection 302.05 – Mixing .....3  
Subsection 302.06 – Transporting and Placing on Subgrade .....3  
Subsection 302.07 – Compacting and Finishing.....3  
Subsection 302.09 – Protection and Curing.....4  
Subsection 302.12 – Acceptance Requirements .....4  
**SECTION 305 – SUBGRADE LAYER**  
Subsection 305.06 – Payment .....4  
**SECTION 307 – PERMEABLE BASES**  
Subsection 307.02 – Materials.....5  
**SECTION 308 – IN-PLACE CEMENT TREATED BASE COURSE**  
All Subsections .....5

**PART V – ASPHALTIC PAVEMENTS**

**SECTION 502 – SUPERPAVE ASPHALTIC CONCRETE MIXTURES**  
Subsection 502.02 – Materials.....5  
Subsection 502.14 – Lot Sizes.....6  
**SECTION 508 – STONE MATRIX ASPHALT**  
Subsection 508.01 – Description .....6  
Subsection 508.02 – Materials.....7

**PART VI – RIGID PAVEMENT**

**SECTION 602 – PORTLAND CEMENT CONCRETE PAVEMENT  
REHABILITATION**  
Subsection 602.17 – Payment.....7

**PART VII – INCIDENTAL CONSTRUCTION**

**SECTION 701 – CULVERTS AND STORM DRAINS**  
All Subsections .....7  
**SECTION 704 – GUARD RAIL**  
Subsection 704.03 – General Construction Requirements .....18  
**SECTION 706 – CONCRETE WALKS, DRIVES AND INCIDENTAL PAVING**  
All Subsections .....18  
**SECTION 713 – TEMPORARY TRAFFIC CONTROL**  
Subsection 713.06 – Pavement Markings.....20  
**SECTION 729 – TRAFFIC SIGNS AND DEVICES**  
Subsection 729.02 – Materials.....21  
Subsection 729.04 – Fabrication of Sign Panels and Markers.....22

**PART VIII – STRUCTURES**

**SECTION 804 – DRIVEN PILES**  
Subsection 804.08 – Construction Requirements .....22

**PART IX – PORTLAND CEMENT CONCRETE**

**SECTION 901 – PORTLAND CEMENT CONCRETE**  
Subsection 901.06 – Quality Control of Concrete.....22  
Subsection 901.08 – Composition of Concrete.....22

**PART X – MATERIALS**

**SECTION 1001 – HYDRAULIC CEMENT**

Subsection 1001.01 – Portland Cement .....23

**SECTION 1003 – AGGREGATES**

Subsection 1003.02 – Aggregates for Portland Cement Concrete and Mortar .....23

**SECTION 1005 – JOINT MATERIALS FOR PAVEMENTS AND STRUCTURES**

Subsection 1005.04 – Combination Joint Former/Sealer .....24

**SECTION 1006 – CONCRETE AND PLASTIC PIPE**

Subsection 1006.09 – Plastic Yard Drain Pipe .....25

**SECTION 1013 – METALS**

Subsection 1013.09 – Steel Piles .....25

**SECTION 1015 – SIGNS AND PAVEMENT MARKINGS**

Subsection 1015.04 – Sign Panels .....25

Subsection 1015.05 – Reflective Sheeting.....26

Subsection 1015.11 – Preformed Plastic Pavement Marking Tape .....30

**SECTION 1020 – TRAFFIC SIGNALS**

Subsection 1020.01 – Traffic Signal Heads.....31

Subsection 1020.04 – Poles for Traffic Signal Systems .....32

**LOUISIANA  
DEPARTMENT OF TRANSPORTATION AND DEVELOPMENT  
SUPPLEMENTAL SPECIFICATIONS**

The 2006 Louisiana Standard Specifications for Roads and Bridges and supplemental specifications thereto are amended as follows.

**PART I – GENERAL PROVISIONS**

**SECTION 101 – GENERAL INFORMATION, DEFINITIONS, AND TERMS:**

Subsection 101.03 – Definitions (07/07), Pages 3 – 13.

Delete the definition for “Proposal/Bid Guaranty” and substitute the following.

Proposal / Bid Guaranty. The required security furnished with a bid. The only form of security acceptable is a Bid Bond.

**SECTION 102 – BIDDING REQUIREMENTS:**

Subsection 102.09 – Proposal / Bid Guaranty (07/07), Page 19.

Delete the contents of this subsection and substitute the following.

PROPOSAL/BID GUARANTY. Each bid shall be accompanied by a proposal/bid guaranty in an amount not less than five percent of the total bid amount when the bidder's total bid amount as calculated by the Department in accordance with Subsection 103.01 is greater than \$50,000. No proposal/bid guaranty is required for projects when the bidder's total bid amount as calculated by the Department is \$50,000 or less. The official total bid amount for projects that include alternates is the total of the bidder's base bid and all alternates bid on and accepted by the Department. The proposal/bid guaranty submitted by the bidder shall be a bid bond made payable to the contracting agency as specified on the bid bond form provided in the construction proposal. No other form of security will be accepted.

The bid bond shall be on the "Bid Bond" form provided in the construction proposal, on a form that is materially the same in all respects to the "Bid Bond" form provided, or on an electronic form that has received Department approval prior to submission. The bid bond shall be filled in completely, shall be signed by an authorized officer, owner or partner of the bidding entity, or each entity representing a joint venture; shall be signed by the surety's agent or attorney-in-fact; and shall be accompanied by a notarized document granting general power of attorney to the surety's signer. The bid bond shall not contain any provisions that limit the face amount of the bond.

The bid bond will be written by a surety or insurance company that is in good standing and currently licensed to write surety bonds in the State of Louisiana by the Louisiana Department of Insurance and also conform to the requirements of LSA-R.S. 48:253.

All signatures required on the bid bond may be original, mechanical reproductions, facsimiles or electronic. Electronic bonds issued in conjunction with electronic bids must have written Departmental approval prior to use. The Department will make a listing of approved electronic sureties providers on the Bidx.com site.

**SECTION 107 – LEGAL RELATIONS AND RESPONSIBILITY TO PUBLIC:**

Subsection 107.05 – Federal Aid Participation (04/08), Pages 57 and 58.

Delete the second paragraph.

**SECTION 108 – PROSECUTION AND PROGRESS:**

Subsection 108.04 – Prosecution of Work (03/05) Pages 74 and 75.

Add the following sentence to the third paragraph of Heading (b).

Should the surety or the Department take over prosecution of the work, the contractor shall remain disqualified for a period of one year from the completion of the project, unless debarment proceedings are instituted.

When the Department of Transportation and Development is not the contracting agency on the project, the second paragraph under Heading (c) is deleted.

**PART II – EARTHWORK**

**SECTION 202 – REMOVING OR RELOCATING STRUCTURES AND OBSTRUCTIONS:**

Subsection 202.06 – Plugging or Relocating Existing Water Wells (03/04), Page 105.

Delete the first sentence and substitute the following.

All abandoned wells shall be plugged and sealed at the locations shown on the plans, or as directed by the engineer, in accordance with the “Water Well Rules, Regulations, and Standards, State of Louisiana.” This document is available at the Department of Transportation and Development, Water Resources Section, P. O. Box 94245, Baton Rouge, Louisiana 70804-9245. The Water Resource Section’s telephone number is (225) 274-4172.

**PART III – BASE COURSES**

**SECTION 302 – CLASS II BASE COURSE:**

Subsection 302.01 – Description (12/08), Page 150.

Add the following to the third paragraph:

(6) Blended Calcium Sulfate

Subsection 302.02 – Materials (12/08), Pages 150 and 151.

Add the following to the first paragraph:

\_\_\_\_\_ Blended Calcium Sulfate                      1003.01 & 1003.03 (e)

Subsection 302.04 – General Construction Requirements (12/08), Page 152.

Add the following:

Blended calcium sulfate will be allowed in areas of new alignment, fill areas, and cut areas less than one foot.

In cut areas greater than one foot (300 mm), an additional one foot (300 mm) of undercut will be required prior to placement of BCS. The additional undercut area shall be replaced with non-plastic sand embankment and encapsulated with a Class D geotextile fabric. The additional

non-plastic material, geotextile fabric, and undercut shall be at no additional cost to the Department.

Blended calcium sulfate will not be allowed in areas needed to facilitate traffic control or when a soil cement base course is specified in the plans. Blended calcium sulfate shall not be placed within 10 feet (3.0 m) of metal drainage structures. The contractor will be allowed to substitute any untreated Class II base course material listed in Subsection 302.01. Flowable fill under Section 710, or other approved backfill material in Section 701 shall be used to backfill the drainage structure.

Subsection 302.05 – Mixing (08/06) (12/08), Pages 152 and 153.

Delete the first sentence of Subheading (b)(1), In-Place Mixing, and substitute the following.

In-place mixing shall conform to Heading (a)(1) except that the percentage of Type I portland cement required will be 6 percent by volume.

Add Heading (d) as follows:

(d) Blended Calcium Sulfate: Calcium sulfate shall be blended with an approved aggregate or lime prior to placement. The blended calcium sulfate material shall be uniformly mixed and sampled from dedicated stockpiles. Gradation sampling in accordance with Subsection 1003.03 shall be taken from the dedicated stockpiles at the point of material origin.

Subsection 302.06 – Transporting and Placing on Subgrade (12/08), Page 154.

Add the following:

Water shall be added or other suitable means taken to prevent dust during the transporting and placing of dry blended calcium sulfate.

Subsection 302.07 - Compacting and Finishing (12/08), Pages 154 and 155.

Add Heading (e) as follows:

(e) Blended Calcium Sulfate: Blended calcium sulfate shall be placed and spread on the subgrade and compacted to produce layers not exceeding 12 inches (300 mm) compacted thickness. During placement the material shall be thoroughly wetted by application of water to maintain 2 to 4 percent above optimum moisture. After application of water, allow the moisture to reach equilibrium in the base before applying rolling techniques. Rolling of BCS is required to the edge of the embankment or subgrade. Each layer shall be compacted to at least 95 percent of maximum dry density or compacted by an approved established rolling pattern determined by the project engineer before the next layer is placed. Optimum moisture and maximum density shall be determined in accordance with DOTD TR 418 Method G modified to include a maximum drying temperature of 140°F (60°C).

Add Heading (f) as follows:

(f) Proof Rolling: Proof rolling shall be done by a load of 25 tons (25 Mg) in a 12 to 14 cubic yard (9 to 10.5 cubic meters) tandem dump truck with ten wheels or approved loaded truck

**Supplemental Specifications (May 2009)**  
**Page 4 of 32**

determined by the project engineer. Proof rolling shall be a minimum of 5 passes in each direction at the same locations and at a maximum vehicle speed of 3 mph (4.8 km/h).

All BCS base will be tested by proof rolling prior to placement of surfacing material, including asphalt binder. Any irregularities or soft spots shall be corrected prior to placement of the surfacing material. Any rain event on the project site between the proof rolling and placement of the surfacing will require an additional proof rolling as noted above.

Subsection 302.09 – Protection and Curing (12/08), Page 155.

Add Heading (c) as follows:

(c) Blended Calcium Sulfate: Protection and curing of blended calcium sulfate shall be in accordance with Subsection 302.09(b).

Subsection 302.12 – Acceptance Requirements (12/08), Pages 156 – 161.

Add the following to Heading (a):

The acceptance requirements for blended calcium sulfate base course shall be the same as stone base course with the following modifications. Upon completion of compaction operations, the density will be determined in accordance with DOTD TR 401 except that all moisture content determinations for density calculations shall be conducted by oven drying the material for 24 hours at 140°F (60°C). A forced draft type oven capable of maintaining the temperature shall be provided by the contractor for field moisture content determination for density control.

**SECTION 305 – SUBGRADE LAYER:**

Subsection 305.06 – Payment (01/08), Page 184.

Delete the contents of this subsection and substitute the following.

305.06 Payment. Payment for subgrade layer will be made at the contract unit price which includes lime, lime treatment, cement, cement treatment, water, stone, recycled portland cement concrete, crushed slag, blended calcium sulfate, asphaltic concrete, and asphalt curing membrane or prime coat, subject to the payment adjustment provisions of Section 1002 for specification deviations of asphalt materials and Subsection 303.11(a) for density deficiencies of cement treated materials. Adjustments in pay for increase or decrease in the percent cement ordered by the engineer will be in accordance with Subsection 303.13. Adjustments in pay for increase or decrease in the percent lime ordered by the engineer will be based on the price of lime shown on paid invoices (total of all charges). The Materials and Testing Section will provide the payment adjustment percentage for properties of asphalt materials.

Payment for geotextile fabric will be included in the contract unit price for subgrade layer.

Payment will be made under:

Item No.	Pay Item	Pay Unit
305-01	Subgrade Layer _____ in (mm) Thick	Square Yard (Sq m)



**SECTION 307 – PERMEABLE BASES:**

Subsection 307.02 – Materials (09/07), Pages 187 and 188.

Delete the contents of Subheading (b), Asphalt, and substitute the following.

(b) Asphalt: The asphalt for asphalt treated permeable base shall be an approved polymer modified asphalt cement, PG 76-22m, or PG 82-22rm complying with Section 1002. The percentage of asphalt cement shall be 2.0 percent to 4.0 percent by weight (mass) of the total mixture. Asphalt cement content and mixing process shall be such that all aggregates are visibly coated. The mixture shall retain 90 percent coating when tested in accordance with DOTD TR 317.

A job mix formula shall be submitted and approved in accordance with Section 502.

**SECTION 308 – IN-PLACE CEMENT TREATED BASE COURSE:**

All Subsections within Section 308 – (07/07), Pages 191 – 198.

Whenever the reference to “DOTD TR-432, Method D” is used, it shall mean “DOTD TR-432”.

**PART V – ASPHALTIC PAVEMENTS**

**SECTION 502 – SUPERPAVE ASPHALTIC CONCRETE MIXTURES:**

Subsection 502.02 – Materials (08/06) (11/07), Pages 210 – 213.

Delete Table 502-2, Superpave Asphalt Cement Usage under Subheading (a) and substitute the following.

**Table 502-2**  
**Superpave Asphalt Cement Usage**

Current Traffic Load Level	Mixture Type	Grade of Asphalt Cement
Level 1	Wearing Course	PG 70-22m
	Binder Course	PG 70-22m
	Base Course	PG 64-22
Level 2	Wearing Course	PG 76-22m
	Binder Course	PG 76-22m
Level A	Incidental Paving	PG 70-22m

Note: A PG 82-22 rm, Waste Tire Rubber Modified Asphalt, may be substituted for any other grade of asphalt cement.

Delete Table 502-3, Aggregate Friction Rating under Subheading (c)(1) and substitute the following.

**Table 502-3**  
**Aggregate Friction Rating**

Friction Rating	Allowable Usage
I	All mixtures
II	All mixtures
III	All mixtures, except travel lane wearing courses with plan ADT greater than 7000 <sup>1</sup>
IV	All mixtures, except travel lane wearing courses <sup>2</sup>

<sup>1</sup> When plan current average daily traffic (ADT) is greater than 7000, blending of Friction Rating III aggregates and Friction Rating I and/or II aggregates will be allowed for travel lane wearing courses at the following percentages. At least 30 percent by weight (mass) of the total aggregates shall have a Friction Rating of I, or at least 50 percent by weight (mass) of the total aggregate shall have a Friction Rating of II. The frictional aggregates used to obtain the required percentages shall not have more than 10 percent passing the No. 8 (2.36 mm) sieve.

<sup>2</sup> When the average daily traffic (ADT) is less than 2500, blending of Friction Rating IV aggregates with Friction Rating I and/or II aggregates will be allowed for travel lane wearing courses at the following percentages. At least 50 percent by weight (mass) of the total aggregate in the mixture shall have a Friction Rating of I or II. The frictional aggregates used to obtain the required percentages shall not have more than 10 percent passing the No. 8 (2.36 mm) sieve.

Subsection 502.14 – Lot Sizes (11/07), Pages 232 and 233.

Delete the first sentence of the first paragraph and substitute the following.

A lot is a segment of continuous production of asphaltic concrete mixture from the same job mix formula produced for the Department at a specific plant, delivered to a specific DOTD project.

**SECTION 508 – STONE MATRIX ASPHALT:**

Subsection 508.01 – Description (09/07), Page 274.

Delete this subsection and substitute the following.

508.01 DESCRIPTION. This work consists of furnishing and constructing Stone Matrix Asphalt (SMA) which is a plant mixed asphalt concrete wearing course for high traffic applications. This mixture is a rut resistant hot mix design with stone on stone contact. The mixture shall be composed of a PG 76-22m, or PG 82-22rm asphalt cement and a gap graded coarse aggregate structure. Mineral filler and/or fibers shall be used to control draindown. This work shall be in accordance with these specifications, plan details, and as directed. All requirements of Section 502 apply to Stone Matrix Asphalt, except as modified herein. All plant and paving equipment and processes must meet the requirements of Section 503.

Mixture used for shoulder may be Stone Matrix Asphalt or any mixture type shown in Table 502-5.

Subsection 508.02 – Materials (09/07), Page 274.

Delete the contents of subheading (a), Asphalt Cement and substitute the following.

(a) Asphalt Cement: Asphalt cement shall be PG 76-22m, or PG 82-22rm as listed on QPL 41 and complying with Section 1002.

## **PART VI – RIGID PAVEMENT**

### **SECTION 602 – PORTLAND CEMENT CONCRETE PAVEMENT REHABILITATION:**

Subsection 602.17 – Payment (09/07), Pages 341 – 344.

Delete the last paragraph of Subheadings (d), Full Depth Corner Patching of Jointed Concrete Pavement, (e) Full Depth Patching of Jointed Concrete Pavement, and (g) Patching Continuously Reinforced Concrete Pavement, and substitute the following.

Payment for deteriorated base course removed as directed by the engineer and replaced with concrete will be made as follows: The value per inch (mm) thickness will be determined by dividing the contract unit price per square yard (sq m) by the plan thickness. Thickness of patches will be measured from the surface that exists at the time of patching. Payment for the additional thickness will be made at 50 percent of the value per inch (mm) thus determined.

## **PART VII – INCIDENTAL CONSTRUCTION**

### **SECTION 701 – CULVERTS AND STORM DRAINS:**

All Subsections within Section 701 (08/07), Pages 347 – 358.

Delete Section 701, Culverts and Storm Drains and substitute the following.

### **SECTION 701 CULVERTS AND STORM DRAINS**

701.01 DESCRIPTION. This work consists of furnishing, installing, and cleaning pipe, pipe arch, storm drains and sewers, also referred to as culverts or conduit, in accordance with these specifications and in conformity with lines and grades shown on the plans or established.

701.02 MATERIALS. Materials shall comply with the following sections and subsections:

Usable Soil	203.06(a)
Selected Soil	203.06(b)
Plastic Soil Blanket	203.10
Mortar	702.02
Flowable Fill	710
Portland Cement Concrete	901
Reclaimed Asphaltic Pavement (RAP)	1003.01 & 1003.04(d)
Stone	1003.03(b)
Recycled Portland Cement Concrete	1003.03(c)
Granular Material	1003.07
Bedding Material	1003.08
Concrete Sewer Pipe	1006.02
Reinforced Concrete Pipe	1006.03
Reinforced Concrete Pipe Arch	1006.04
Gasket Materials	1006.06
Plastic Pipe	1006.07
Split Plastic Coupling Bands	1006.07(d)(4)
Plastic Yard Drain Pipe	1006.09
Bituminous Coated Corrugated Steel Pipe and Pipe Arch	1007.02
Structural Plate for Pipe, Pipe Arch and Arch	1007.04
Corrugated Aluminum Pipe and Pipe Arch	1007.05
Coupling Bands	1007.09
Reinforcing Steel	1009
Geotextile Fabric	1019

(a) Side Drain Pipe or Side Drain Pipe Arch: When the item for Side Drain Pipe or Side Drain Pipe Arch is included in the contract, the contractor has the option of furnishing reinforced concrete pipe or reinforced concrete pipe arch, corrugated metal pipe or corrugated metal pipe arch, or plastic pipe, as allowed by EDSM II.2.1.1 or unless otherwise specified.

(b) Cross Drain Pipe or Cross Drain Pipe Arch: When the item for Cross Drain Pipe or Cross Drain Pipe Arch is included in the contract, the contractor has the option of furnishing reinforced concrete pipe or reinforced concrete pipe arch, corrugated metal pipe or corrugated metal pipe arch, or plastic pipe, as allowed by EDSM II.2.1.1 or unless otherwise specified.

(c) Storm Drain Pipe or Storm Drain Pipe Arch: When the item for Storm Drain Pipe or Storm Drain Pipe Arch is included in the contract, the contractor has the option of furnishing reinforced concrete pipe or reinforced concrete pipe arch, or plastic pipe, as allowed by EDSM II.2.1.1 or unless otherwise specified.

(d) Yard Drain Pipe: When the item for Yard Drain Pipe is included in the contract, the contractor has the option of furnishing concrete sewer pipe, plastic yard drain pipe or plastic pipe in accordance with Section 1006 unless otherwise specified.

(e) Material Type Abbreviations:

(1) Reinforced Concrete Pipe:

RCP	Reinforced Concrete Pipe
RCPA	Reinforced Concrete Pipe Arch

(2) Corrugated Metal Pipe:

CAP	Corrugated Aluminum Pipe
CAPA	Corrugated Aluminum Pipe Arch
CMP	Corrugated Metal Pipe
CMPA	Corrugated Metal Pipe Arch
CSP	Corrugated Steel Pipe
CSPA	Corrugated Steel Pipe Arch
BCCSP	Bituminous Coated Corrugated Steel Pipe
BCCSPA	Bituminous Coated Corrugated Steel Pipe Arch

(3) Plastic Pipe:

PP	Plastic Pipe
PVCP	Polyvinyl Chloride Pipe
RPVCP	Ribbed Polyvinyl Chloride Pipe
CPEPDW	Corrugated Polyethylene Pipe Double Wall

(f) Joint Type Abbreviations:

T1	Type 1 Joint
T2	Type 2 Joint
T3	Type 3 Joint

(g) Quality Assurance for Pipe: Manufacturing plants will be periodically inspected for compliance with specified manufacturing methods, and material samples will be randomly obtained for laboratory testing for verification of manufacturing lots. Materials approved at the manufacturing plant will be subject to visual acceptance inspections at the jobsite or point of delivery.

701.03 EXCAVATION. For all pipe, when the sides of the trench are stable as evidenced by the sides of the trench being able to maintain a vertical cut face, the minimum trench width at the bottom of the excavation will be 18 inches (460mm) on either side of the outside diameter of the pipe. If the sides of the trench are unstable, the width of the trench at the bottom of the excavation, for plastic or metal pipe, shall be a minimum width of at least 18 inches (460mm) or one pipe diameter on each side of the outside diameter of the pipe, which ever is greater. Surplus material or excavated material that does not conform to the requirements of Subsection 203.06(a) shall be satisfactorily disposed of in accordance with Subsection 202.02. Moisture controls including backfill materials selection and dewatering using sumps, wells, well points or other approved processes may be necessary to control excess moisture during excavation, installation of bedding, over-excavated trench backfilling, pipe placement and pipe backfill.

(a) Over-excavation: When unsuitable soils as defined in Subsection 203.04 or a stable, non-yielding foundation cannot be obtained at the established pipe grade, or at the grade established for placement of the bedding, unstable or unsuitable soils below this grade shall be removed and replaced with granular material meeting the requirements of Subsection 1003.07,

## **Supplemental Specifications (May 2009)**

### **Page 10 of 32**

bedding materials meeting the requirements of Subsection 1003.08 or Type A backfill. All granular, backfill materials placed below the established pipe or bedding grade shall be placed in lifts not exceeding 8 inches (200 mm) thick and sufficiently compacted by hand or a dynamic mechanical hand compaction device over the surface of each lift to form a stable, non-yielding foundation at the surface of the established bedding or pipe grade.

When rock is encountered, it shall be removed below grade and replaced with material complying with Subsection 1003.07, bedding materials meeting the requirements of Subsection 1003.08 or Type A backfill. The compacted earth cushion shall have a thickness under the pipe of at least 1/2 inch per foot (40 mm/m) of fill height over the top of the pipe with a minimum thickness of 8 inches (200 mm). All granular, backfill materials placed below the established pipe or bedding grade shall be placed in lifts not exceeding 8 inches (200 mm) thick and sufficiently compacted by hand or a dynamic mechanical hand operated compaction device over the surface of each lift to form a stable, non-yielding foundation at the surface of the established bedding or pipe grade.

Materials used to backfill in an over-excavated portion of a trench do not require encasement in a Geotextile Fabric.

Density of approved materials placed in over-excavated trenches will not be measured or determined.

**701.04 FORMING PIPE BED.** Bedding material, when specified, shall be constructed in accordance with Section 726. Materials allowed for bedding shall be as specified in Subsection 1003.08 or may be Type A backfill materials. When bedding materials are specified, additional excavation shall be performed below established pipe grade and the bedding material placed in lifts not exceeding 8 inches (200 mm) thick and lightly compacted by hand or a dynamic hand compaction device over the surface of each lift.

When the bottom of the pipe is not laid in a trench but is constructed above natural soils, a uniform bed shall be constructed as specified for the bottom of a trench.

Density of approved bedding materials will not be measured or determined.

**701.05 LAYING PIPE.** Pipe laying shall begin at the downstream end of the line. The pipe shall be in contact with the foundation throughout its length. Bell or groove ends of pipe and outside circumferential laps of riveted metal pipe shall be placed facing upstream. Riveted seam metal pipe shall be placed with longitudinal laps at sides. Pipes in each continuous line shall have the same wall thickness. Metal pipes provided with lifting lugs shall be handled only by these lugs.

After pipe has been laid and before backfill is placed, the engineer will inspect the pipe for alignment, grade, integrity of joints, and coating damage.

**701.06 JOINING PIPE.**

**(a) Joint Usage:**

(1) Type 1 (T1) joints shall be used for side drains under drives and similar installations.

(2) Type 2 (T2) joints shall be used for cross drains under roadways, including turnouts.

(3) Type 3 (T3) joints shall be used for closed storm drain systems, flumes and siphons.

**(b) Concrete Pipe:** Concrete pipe may be either bell and spigot, or tongue and groove. The method of joining pipe sections shall be such that ends are fully entered and inner surfaces are flush and even.

An approved mechanical pipe puller shall be used for joining pipes over 36 inches (900 mm) in diameter. For pipe 36 inches (900 mm) or less in diameter, any approved method for joining pipe may be used which does not damage the pipe.

Joints shall comply with Subsection 1006.05, and shall be sealed with gasket material installed in accordance with the manufacturer's recommendations.

**(c) Metal Pipe:** Metal pipe shall be firmly joined by coupling bands. Bands shall be centered over the joint.

For Type 1 joints, approved gasket material shall be placed in one corrugation recess on each side of the joint at the coupling band and on each band connection in such manner to prevent leakage.

When Type 2 or 3 joints are specified, joining of metal pipe sections shall conform to the following provisions:

(1) General: Band joints shall be sealed with gasket material. Gasket material shall be placed in accordance with the plan details.

(2) Circular Section: Connecting bands shall be of an approved design and shall be installed in accordance with plan details.

(3) Arch Section: Connecting bands shall be a minimum of 12 inches (300 mm) wide for pipe arch less than 36 inches (900 mm) round equivalent diameter, and a minimum of 21 inches (525 mm) wide for 36 inches (900 mm) round equivalent diameter pipe arch and greater. Bands shall be connected at the ends by approved angle or strap connections. Connecting bands used for 36 inches (900 mm) round equivalent diameter pipe arch and above shall be 2-piece bands.

**(d) Plastic Pipe:** Joints for plastic pipe shall be either bell and spigot or split coupling bands.

(1) Bell and Spigot Type Joint System: The method of joining pipe sections shall be such that ends are fully entered and inner surfaces are flush and even.

Any approved method for joining pipe may be used which does not damage the pipe.

Joints shall be approved and shall be sealed with a gasket system utilizing gasket material complying with Subsection 1006.06(a).

(2) Split Coupling Type Joint System: Split coupling bands shall comply with all dimensional and material requirements of Subsection 1006.07. The bands shall be centered over the joint. The split coupling band shall be secured to the pipe with a minimum of five stainless steel or other approved corrosion resistant bands.

Joints shall be approved and shall be sealed with gasket material. Gasket material shall be placed in the first two corrugation recesses on each side of the pipe connections. Gasket material shall also be placed on each band connection to prevent leakage. When flexible plastic gasket material is used it shall be a minimum of 1/2 inch (13 mm) in size. The bands shall be tightened to create overlap of the band and shall adequately compress the gasket material.

(e) Connections: Approved connections shall be used when joining new pipes to existing pipes. When concrete collars are required in order to extend the ends of existing pipes that have been damaged or to join different types or sizes of pipes, the concrete collars shall be constructed in accordance with plan details, the applicable requirements of Section 901, and as directed.

(f) Geotextile Fabric, Pipe Joints: For concrete, metal and plastic pipes, Types 2 and 3 joints shall be wrapped with geotextile fabric for a minimum of 12 inches (300 mm) on each side of joint for pipe 36 inches (900 mm) or less in diameter and a minimum of 18 inches (450 mm) on each side of the joint for pipe greater than 36 inches (900 mm) in diameter. Ends of the fabric shall be lapped at least 10 inches (250 mm). The edges and ends of fabric shall be suitably secured for the entire circumference of the pipe.

701.07 RELAYING PIPE. If specified or directed, existing pipes shall be removed and suitable sections relaid as specified for new pipes.

#### 701.08 BACKFILLING.

(a) General: Prior to backfilling, pipes found to be damaged or out of alignment or grade shall be removed and reinstalled, or replaced.

Type A backfill material shall be stone, recycled portland cement concrete, flowable fill, or RAP.

Type B backfill materials are selected soils. Where Type B backfill materials are called for, Type A backfill materials may be substituted.

When corrugated metal pipe is used, the backfill material shall be tested and shall have a resistivity greater than 1500 ohm-cm and a pH greater than 5 when tested in accordance with DOTD TR 429 and DOTD TR 430 respectively.

When Type A backfill material is used, geotextile fabric surrounding this backfill shall be placed in accordance with Subsection 726.03 between the aggregate backfill material and all other natural or placed soils in the trench or embankment. Care shall be taken to prevent damage to geotextile fabric during placement of backfill material. For concrete pipe, the fabric shall enclose not only the initial backfill but shall be wrapped over the top of the pipe with at least 12 inches (300 mm) of overlap.

When a trench box or trench sheeting is used in unstable soils and/or for worker safety, and when moved during backfilling operations, filling and additional compaction of the disturbed zone of backfill must take place immediately and in a manner acceptable to the engineer.



Initial backfill is a structural backfill encasing the pipe from the bottom of the pipe to the springline for concrete pipe and to a point one foot (0.3 m) above the top of the pipe for both metal and plastic pipe. Final backfill is not a structural backfill and shall extend from the top of the initial backfill to the top of the natural ground or subgrade in cut areas or to the top of existing ground in fill areas. Any fill required above the final backfill is considered and treated as embankment.

(b) Backfill Applications: For projects using A+B+C bidding method where rigid and flexible pavement alternates are considered, backfill application (2) below, "Cross Drains Under Flexible Pavements", shall apply for either rigid or flexible pavements.

(1) Under Concrete Pavements: Type B backfill may be used as initial and final backfill for all pipes, culverts or drains under concrete pavements. Placement and compaction shall be as specified in Heading (d) below.

(2) Cross Drains Under Flexible Pavements: All reaches, exclusive of those portions of the pipe which are under shoulders, of cross drains and all other culverts, pipes or drains that cross the centerlines of the new roadway or centerlines of existing roadways, such as intersections and are under flexible pavements shall receive an initial backfill of Type A material. Type B backfill materials may be used as final backfill for all pipes. Placement and compaction shall be as specified in Heading (c) and (d) below. Where the subgrade is above existing ground, embankment material as specified for the remainder of the project shall be used from the top of the final backfill to the top of the established embankment grade.

(3) Other Drains Under Flexible Pavements: All reaches of all culverts, pipes or drains under flexible pavements that do not cross the centerlines of new roadway or centerlines of existing roadways, and exclusive of those portions of the pipe which are totally under shoulders, shall receive an initial and final backfill of Type B material. Placement and compaction shall be as specified in Heading (d) below. Where the subgrade is above existing ground, embankment material as specified for the remainder of the project shall be used from the top of the final backfill to the top of the established embankment grade.

(4) Other Areas: All culverts, pipes or drains in nonpaved areas or paved areas that serve as driveways or shoulders shall receive an initial and final backfill of Type B material. Placement and compaction shall be as specified in Heading (d) below.

(5) Pipes Subject to Construction Traffic; The embankment or pipe backfill shall be constructed to a minimum of 24 inches (600 mm) over the pipe before heavy construction equipment is allowed to cross the installation. Where practical, installations with less than 24 inches (600 mm) of cover over the top of the pipe shall be constructed after heavy hauling is completed over the pipe location. After completion of hauling operations, the contractor shall remove excess cover material. Pipe damaged by hauling and backfilling operations shall be removed and reinstalled, or replaced, at no direct pay.

(c) Placement and Compaction; Type A Backfill: For all pipes, culverts and conduits under paved and nonpaved areas, where Type A backfill material is used, the Type A backfill shall be thoroughly hand compacted under the pipe haunches and then dynamically compacted in layers not exceeding 8 inches (200 mm) compacted thickness. Compaction under the haunches of the pipe shall initially be by hand tamping or other acceptable means, until a level is reached that the dynamic tamping can commence. Each lift shall be compacted by applying at least eight

passes of a hand operated, dynamic mechanical compaction device over the surface of each lift. With approval of the engineer, layer thickness may be increased to 12 inches (300 mm) with verification of satisfactory installation and performance. If flowable fill is used it shall be furnished, placed and consolidated in accordance with Section 710. The contractor shall control placement operations during initial backfill operations so as not to damage protective coatings on metal pipes. The contractor shall repair damaged coatings at no additional pay.

(d) Placement and Compaction; Type B Backfill: For all pipes, culverts and conduits, where Type B backfill is allowed, the Type B material shall be placed in layers not exceeding 8 inches (200 mm) compacted thickness. Compaction shall be with suitable mechanical equipment. With approval of the engineer, layer thickness may be increased to 12 inches (300 mm) with verification of satisfactory installation and performance.

(e) Placement and Compaction; Trenchless or Partial Trench Condition: All pipes, culverts, drains and conduits placed with any portion of the pipe above existing ground must also comply with Subsections (a),(b) (c) and (d) above for the portion of the pipe within a trench and that portion of the pipe not constructed in a trench. The width of initial and final backfill of that portion above existing ground and not within a trench will be constructed to such a width that the requirements for placement, compaction and density are met.

(f) Density Requirements: The in place density of Type A backfill materials and bedding materials, will not be measured or determined. Type A backfill, exclusive of RAP and flowable fill, shall be placed at or near optimum moisture content determined in accordance with DOTD TR 415 or 418. RAP materials shall be placed and compacted in a slightly moist condition.

The maximum dry density of initial or final Type B backfill under all paved areas which are to be under traffic will be determined in accordance with DOTD TR 415 or TR 418 and in-place density determined in accordance with DOTD TR 401. Initial and final Type B backfill under all paved areas, under traffic, shall be placed at or near optimum moisture content determined in accordance with DOTD TR 415 or TR 418. Each layer shall be compacted by approved methods prior to the placement of a subsequent layer. The engineer will approve the compaction method based upon validation that such method, including moisture control, will achieve at least 95 percent of maximum dry density as determined in accordance with DOTD TR 401. With approval of the engineer, density testing may be waived on subsequent layers with backfill installation in accordance with approved compaction methods and continued satisfactory performance.

Initial and final backfill in unpaved areas or paved areas such as shoulders or driveways, shall be placed evenly and compacted along the length of the culvert, pipe or drain from the top of the initial backfill to the top of the subgrade. Layered backfill shall be compacted at least to the density of the adjoining existing soils or the compaction required of the laterally adjoining layers of soil immediately outside the trench for embankment elevations. Initial and final backfill shall be placed and compacted at or near optimum moisture content determined in accordance with DOTD TR 415 or TR 418.

**701.09 INSPECTION OF PIPES.** After completion of embankment and prior to roadway surfacing, the engineer shall inspect pipes for proper alignment and integrity of joints. Any misaligned pipe or defective joints shall be corrected by the contractor at no direct pay.

(a) Plastic Pipe: Installed plastic pipe shall be tested to ensure that vertical deflections do not exceed 5.0 percent. Maximum allowable deflections shall be governed by the mandrel requirements stated herein.

Deflection tests shall be performed no sooner than 30 calendar days after installation and compaction of backfill. The pipe shall be cleaned and inspected for offsets and obstructions prior to testing.

For pipe 36 inches (900 mm) and less in diameter, a mandrel shall be pulled through the pipe by hand to ensure that maximum allowable deflections have not been exceeded. The mandrel shall be approved by the engineer prior to use. Use of an unapproved mandrel or a mandrel altered or modified after approval will invalidate the test. If the mandrel fails to pass, the pipe is overdeflected.

Unless otherwise permitted, overdeflected pipe shall be uncovered and, if not damaged, reinstalled. Damaged pipe shall not be reinstalled, but shall be removed and replaced with new pipe. Any pipe subjected to any method or process other than removal, which attempts, even successfully, to reduce or cure any overdeflection, shall be removed and replaced with new pipe.

The mandrel shall be a rigid, nonadjustable, odd-numbered legged (minimum 9 legs) mandrel having a length not less than its nominal diameter or 24 inches (600 mm), whichever is less. The minimum diameter at any point shall be 5.0 percent less than the base inside diameter of the pipe being tested. The mandrel shall be fabricated of steel, aluminum or other approved material fitted with pulling rings at each end. The nominal pipe size and outside diameter of the mandrel shall be stamped or engraved on some segment other than a runner. A suitable carrying case shall be furnished.

For pipe larger than 36 inches (900 mm) in diameter, deflection shall be determined by a method approved by the engineer. If a mandrel is selected, the minimum diameter, length, and other requirements shall conform to the above requirements.

Mandrel testing shall be conducted by the contractor in the presence of the engineer. Mandrel testing shall be at no direct pay.

(b) Metal Pipe: If the inside diameter of metal pipe or rise dimension of metal pipe arch deflects more than 5.0 percent from original dimensions, they shall be removed and reinstalled, unless they do not rebound or are damaged. Pipe or pipe arch which are damaged or do not rebound shall be removed and replaced at no direct pay. Measurement of deflection will be made by the engineer away from rerolled ends.

#### 701.10 CLEANING PIPES.

(a) Existing Pipes: Pipes designated to be cleaned shall be cleaned of soil, debris and other materials to the invert of the pipe. Designated pipes shall be cleaned by approved methods that will not damage the pipes. Any damage caused by the contractor's operations shall be satisfactorily repaired at no direct pay.

Removed soil, debris and other materials shall be disposed of in accordance with Subsection 202.02 or as otherwise approved in writing.

(b) Contractor Installed Pipes: Prior to final acceptance, pipes shall be cleaned of all debris and soil to the invert of the pipe at no direct pay.

**Supplemental Specifications (May 2009)**  
**Page 16 of 32**

Removed soil, debris and other materials shall be disposed of in accordance with Subsection 202.02 or as otherwise approved in writing.

**701.11 STUBBING AND PLUGGING PIPES.** When it is required that pipes be plugged, such plugs shall be constructed of Class R concrete complying with Section 901. Thickness of plug and method of construction shall be as directed.

When new pipes are to be stubbed into new or existing pipes or other structures, the connection shall be made with approved mortar complying with Subsection 702.02.

**701.12 MEASUREMENT.** Pipe, both new and relaid, will be measured in linear feet (lin m) as follows unless stated otherwise.

(a) Pipe not confined by fixed structures will be measured by the number of joints at the nominal length of each joint.

(b) Pipe confined by fixed structures will be measured along the pipe between the termini of pipe in structure walls.

(c) Pipe confined by a fixed structure on one end and unconfined at the other end will be measured along the pipe from the terminus of pipe in the structure wall to the unconfined end of pipe.

(d) Fabricating of pipe tees, elbows and other fittings will be measured per each fitting. The length of pipe in such fittings will be included in the pay length measurement of pipes of which they form a part.

(e) Excavation required for installation of pipes will not be measured for payment, except as otherwise specified in Subsection 203.14.

(f) Furnishing and placing backfill material below existing ground level for pipes will not be measured for payment. Backfill material needed to complete backfill above natural ground and around pipes that extend above natural ground will be measured and payment will be made under applicable earthwork items. When specified, flowable fill will be measured and paid for in accordance with Section 710.

(g) Plugging and stubbing of pipes will not be measured for payment.

(h) Cleaning existing pipes will be measured by the length of pipe cleaned and accepted.

(i) Concrete collars will be measured per each.

**701.13 PAYMENT.**

(a) Payment for pipe will be made at the contract unit price per linear foot (lin m) of the types and sizes specified.

When plastic pipe is specified on the plans or elected to be used by the contractor, payment will be made at the contract unit price per linear foot (lin m) of the types and sizes specified in accordance with the payment schedule of Table 701-1.

Table 701-1  
 Payment Schedule for Plastic Pipe

Percent Payment	Stage of Completeness
75	After placement and backfill has been completed
25	After the pipe has met vertical deflection requirements in accordance with Subsection 701.09(a)

(b) Payment for fabricating pipe tees, elbows and other fittings will be made at the contract unit price per each fitting.

(c) When unstable conditions are encountered, the additional excavation will not be measured for payment; however, the additional materials furnished and placed for the pipe foundation will be measured and paid for as follows:

(1) Granular Materials: Payment will be made under the embankment item. The net section volume of the materials will be multiplied by 3 to determine the pay volume. When the contract does not include a pay item for embankment, payment will be made in accordance with Subsection 104.02.

(2) Bedding Material: Measurement and payment will be made in accordance with Section 726. When the contract does not include a pay item for bedding material, payment will be made in accordance with Subsection 104.02.

(d) Payment for cleaning existing pipes will be made at the contract unit price per linear foot (lin m).

(e) Payment for concrete collars will be made at the contract unit price per each.

Payment will be made under:

Item No.	Pay Item	Pay Unit
701-01	Cross Drain Pipe (Size & Type)	Linear Foot (Lin m)
701-02	Cross Drain Pipe Arch (Size & Type)	Linear Foot (Lin m)
701-03	Storm Drain Pipe (Size & Type)	Linear Foot (Lin m)
701-04	Storm Drain Pipe Arch (Size & Type)	Linear Foot (Lin m)
701-05	Side Drain Pipe (Size)	Linear Foot (Lin m)
701-06	Side Drain Pipe Arch (Size)	Linear Foot (Lin m)
701-07	Yard Drain Pipe (Size)	Linear Foot (Lin m)
701-08	Relaying Pipe	Linear Foot (Lin m)
701-09	Fabricating Pipe Fittings	Each
701-10	Reinforced Concrete Pipe (Extension)	Linear Foot (Lin m)
701-11	Reinforced Concrete Pipe Arch (Extension)	Linear Foot (Lin m)
701-12	Corrugated Metal Pipe (Extension)	Linear Foot (Lin m)
701-13	Corrugated Metal Pipe Arch (Extension)	Linear Foot (Lin m)

**Supplemental Specifications (May 2009)**  
**Page 18 of 32**

701-14	Cleaning Existing Pipes	Linear Foot (Lin m)
701-15	Concrete Collar	Each
701-16	Plastic Pipe (Extension)	Linear Foot (Lin m)

**SECTION 704 – GUARD RAIL:**

Subsection 704.03 – General Construction Requirements (01/05), Pages 368 and 369.

Add the following to Heading (d), Guard Rail End Treatments.

All end treatments shall bear a label indicating the manufacturer and exact product name of the end treatment along with its assigned NCHRP 350 test level. This label shall resist weathering and shall be permanently affixed to the railing in such a way as to be readily visible.

**SECTION 706 – CONCRETE WALKS, DRIVES AND INCIDENTAL PAVING:**

All Subsections within Section 706 (04/08), Pages 375 – 377.

Delete Section 706, Concrete Walks, Drives and Incidental Paving and substitute the following.

**SECTION 706**  
**CONCRETE WALKS, DRIVES AND INCIDENTAL PAVING**

706.01 DESCRIPTION. This work consists of furnishing and constructing portland cement concrete walks, handicapped curb ramps, drives and incidental paving slabs in accordance with these specifications and in conformity with lines, grades and dimensions shown on the plans or established.

706.02 MATERIALS. Materials shall comply with the following Section or Subsections.

Portland Cement Concrete (Class M)	901
Joint Filler	1005.01(c)
Reinforcing Steel	1009.01
Curing Materials	1011.01

706.03 CONSTRUCTION REQUIREMENTS.

(a) Excavation: Excavation shall be made to required depth and width. The top of the subgrade shall be shaped and compacted to a firm, even surface conforming to the section shown on the plans. Unsuitable material shall be removed and disposed of in accordance with Subsection 202.02 and replaced with approved material at no direct pay.

(b) Forms: Forms shall be of wood or metal and shall extend the full depth of concrete. Forms shall be straight, clean and of sufficient strength to resist the pressure of concrete. Bracing of forms shall be such that forms remain in horizontal and vertical alignment until their removal.

Concrete may be placed by slip-form methods. Slip-formed concrete shall be placed with an approved machine designed to spread, vibrate, consolidate and finish concrete in one pass of the machine in such manner that minimum hand finishing is necessary. Sliding forms shall be

rigidly held together to prevent spreading of forms. After the passing of the side forms there shall be no noticeable slumping of concrete.

(c) Subgrade: The subgrade shall be thoroughly moistened immediately prior to placing concrete.

(d) Placing and Finishing: Concrete shall be placed on the subgrade, struck off to required thickness and tamped sufficiently to bring the mortar to the surface. The surface shall be finished with a wood float or steel trowel followed by brushing to a slightly rough finish. Joints and edges shall be rounded with an edging tool having a 1/4-inch (6 mm) radius.

(e) Joints:

(1) Expansion Joints: Expansion joints shall be filled with 1/2 inch (13 mm) thick preformed expansion joint filler. Expansion joints shall be installed at maximum 100-foot (30 m) intervals, and between intersecting paving and any fixed structure such as a building, bridge or curbing, and between intersecting paving and the handicapped curb ramps. Expansion joint material shall extend for the full width and depth of paving.

(2) Weakened Plane: Weakened planes shall be formed by a jointing tool or other acceptable means. Weakened planes shall extend into concrete for at least 1/4 of the depth and shall be approximately 1/8 inch (3 mm) wide.

a. Walks: Spacing of weakened planes for walks shall be equal to the width of walk.

b. Drives: A longitudinal weakened plane shall be formed along the centerline of drives more than 16 feet (5 m) wide, and transverse weakened planes shall be formed at not more than 16-foot (5 m) intervals.

c. Incidental Paving: Weakened planes for incidental paving shall be formed at intervals not exceeding 30 times the thickness of the concrete in length or width. Incidental paving poured adjacent to jointed concrete shall be jointed to match existing joints, with intermediate joints formed as necessary not to exceed the maximum joint spacing.

(3) Construction Joints: Construction joints shall be formed around manholes, utility poles, etc., extending into paving and 1/4 inch (6 mm) thick preformed expansion joint filler shall be installed in these joints.

(4) Tie-ins: Tie-ins of existing concrete shall be made by full depth sawing at no direct pay.

(f) Curing: Concrete shall be cured in accordance with Subsection 601.10.

(g) Detectable Warning Surface for Handicap Ramps and At-Grade Sidewalk Intersections: Sidewalks, when intersecting with roadways, shall be equipped with a detectable warning surface system consisting of raised truncated domes as a transition between the sidewalk and the street as required by the Americans with Disabilities Act, 28 CFR Part 36, ADA Standards for Accessible Design.

Detectable warnings (truncated domes) shall be installed on the ramp surface over the full width of the ramp throat for a distance of 24 inches (600 mm) in the direction of travel from the back of the curb. Detectable warnings (truncated domes) shall also be installed on at-grade sidewalks intersecting with roadways for a distance of 36 inches (900 mm) in the direction of travel from the end of the sidewalk. Truncated domes shall be laid out on a square grid in order to allow enough space for wheelchairs to roll between the domes.

**Supplemental Specifications (May 2009)**  
**Page 20 of 32**

Light reflectance of the truncated domes and the underlying surface must meet the 70 percent contrast requirement of ADAAG.

706.04 MEASUREMENT. Quantities of concrete walks, drives and incidental paving slabs for payment will be the design quantities as specified on the plans and adjustments thereto. Design quantities will be adjusted if the engineer makes changes to adjust to field conditions, if design errors are proven or if design changes are made. Design areas are based on the horizontal dimensions shown on the plans. Excavation, backfill, reinforcing steel and joint materials will not be measured for payment.

Handicapped curb ramps, including the detectable surface warning system, will be measured per each.

Detectable surface warning systems for at-grade sidewalk intersection will not be measured for payment.

706.05 PAYMENT. Payment for concrete walks, drives and incidental paving will be made on a lot basis at the contract unit price per square yard (sq m), adjusted in accordance with the following provisions. Payment for each lot will be made in accordance with Table 901-6. Size, sampling, and testing of each concrete lot shall be in accordance with the Materials Sampling Manual.

Payment for handicapped curb ramps, including the detectable surface warning system, will be made by each and shall include, but not limited to, curb transitions, detectable warning system, gutter, landing and base.

Payment will be made under:

Item No.	Pay Item	Pay Unit
706-01	Concrete Walk (    inch (mm) Thick)	Square Yard (Sq m)
706-02	Concrete Drive (    inch (mm) Thick)	Square Yard (Sq m)
706-03	Incidental Concrete Paving (    inch (mm) Thick)	Square Yard (Sq m)
706-04	Handicapped Curb Ramps	Each

**SECTION 713 – TEMPORARY TRAFFIC CONTROL:**

Subsection 713.06 – Pavement Markings (08/06), Pages 400 – 403.

Delete Table 713-1, Temporary Pavement Markings and substitute the following.



**Table 713-1  
Temporary Pavement Markings<sup>1,2</sup>**

		Two-lane Highways	Undivided Multilane Highways	Divided Multilane Highways
S H O R T T E R M	ADT<1500; or ADT>1500 and time<3 days	Lane lines 4-foot (1.2 m) tape on 40-foot (12 m) centers; with "Do Not Pass" and "Pass With Care" signs as required		
	ADT>1500; Time>3 days and<2 weeks	Lane lines 4-foot (1.2-m) tape on 40-foot (12-m) centers with no passing zone markings		
	All ADT's with time <2 weeks		Lane lines 4-foot (1.2m) tape on 40-foot (12 m) centers; double yellow centerline	Lane lines 4-foot (1.2 m) tape on 40-foot (12 m) centers
L O N G T E R M	All ADT's with time >2 weeks	Standard lane lines, no-passing zone markings, legends and symbols and when pavement width is 22 feet (6.7 m) or greater, edge lines	Standard lane lines, centerlines, edge lines, and legends and symbols	Standard lane lines, centerlines, edge lines, and legends and symbols.

<sup>1</sup>No-passing zones shall be delineated as indicated whenever a project is open to traffic.

<sup>2</sup>On all Asphaltic Surface Treatments that are open to traffic and used as a final wearing course or as an interlayer, temporary pavement markings (tabs) on 20-foot (6 m) centers shall be used, in lieu of the 4-foot (1.2 m) tape, on 40-foot (12 m) centers.

**SECTION 729 – TRAFFIC SIGNS AND DEVICES:**

**Subsection 729.02 – Materials (04/08), Pages 456 and 457.**

Delete the contents of Heading (a), Sign and Marker Sheeting, and substitute the following.

(a) Sign and Marker Sheeting: Sheeting material for sign panels, delineators, barricades and other markers shall comply with Section 1015. All permanent signs shall meet the requirements of ASTM D 4956, Type X.

**Supplemental Specifications (May 2009)**  
**Page 22 of 32**

Subsection 729.04, Fabrication of Sign Panels and Markers (04/08), Pages 458 – 460.

Delete the third paragraph of Heading (c), Sheeting Application and substitute the following.

ASTM D 4956 Type X reflective sheeting shall be applied with an orientation determined by the engineer to obtain the optimum entrance angle performance. Fabricated vertical splices in ASTM D 4956 Type X reflective sheeting will be allowed only when the horizontal dimension of the sign face or attached shield is in excess of the maximum manufactured width of the sheeting. Fabricated vertical splices in ASTM D 4956 Type X reflective sheeting will also be allowed when the specified orientation will create excessive sheeting waste.

**SECTION 804 – DRIVEN PILES:**

Subsection 804.08 – Construction Requirements (04/07), Pages 548 – 554.

Delete the first sentence of Heading (a), Preboring and substitute the following.

Preboring by augering, wet-rotary drilling, or other methods used to facilitate pile driving will not be permitted unless specified in the plans or allowed by the engineer.

Delete the first sentence of Heading (b), Jetting and substitute the following.

Jetting will not be permitted unless allowed in the plans or allowed by the engineer.

**SECTION 901 – PORTLAND CEMENT CONCRETE:**

Subsection 901.06 – Quality Control of Concrete (08/06), Pages 726 – 731.

Add the following to the contents of Heading (b), Quality Control Tests.

The contractor shall be responsible for monitoring the components (cement, mineral and chemical admixtures, aggregates) in their mix to protect against any changes due to component variations. As component shipments arrive, the contractor shall verify slump, air content and set time by testing at ambient temperatures. The contractor shall make adjustments to the mix design to rectify any changes which would adversely affect constructability, concrete placement or the specifications. The contractor shall submit test results to the Department for review each day of paving. Testing to validate component consistency will be documented on the control logs. Conformance or variation in mix parameters (workability, set times, air content, etc.) shall be noted on the control logs. The contractor shall provide a copy of the proposed testing plan to the engineer for record. Acceptance of the plan does not relieve the contractor's responsibility for consistency.

Subsection 901.08 – Composition of Concrete (12/05), Pages 732 – 734.

Add the following to Heading (a).

The blended cement containing up to 50 percent of grade 100 or grade 120 ground granulated blast-furnace slag must be in compliance with Subsection 1001.04 for portland blast-furnace slag cement.

**SECTION 1001 – HYDRAULIC CEMENT:**

Subsection 1001.01 – Portland Cement (09/07). Page 749.

Delete the contents of this subsection and substitute the following.

1001.01 PORTLAND CEMENT. Portland cement shall be from an approved source listed in QPL 7 and shall comply with AASHTO M 85.

Alkali content calculated as sodium oxide equivalent shall not exceed 0.60 percent by weight for all types of cement.

**SECTION 1003 – AGGREGATES:**

Subsection 1003.02 – Aggregates for Portland Cement Concrete and Mortar (07/07),  
Pages 763 – 766.

Delete the contents of Heading (c), Aggregates for Types B and D Pavements, and substitute the following.

(c) Aggregates for Types B and D Pavements: For the combined aggregates for the proposed portland cement concrete pavement mix, the percent retained based on the dry weight (mass) of the total aggregates shall meet the requirements of Table 1003-1A for the type of pavement specified in the plans. Additionally, the sum of the percents retained on any two adjacent sieves so designated in the table shall be at least 12 percent of the total combined aggregates. The maximum amounts by weight (mass) of deleterious materials for the total aggregate shall be the same as shown in Subsection 1003.02(b).

Table 1003-1A  
Aggregates for Types B and D Pavements

U.S. Sieve	Metric Sieve	Percent Retained of Total Combined Aggregates	
		Pavement Type	
		Type B	Type D
2 1/2 inch	63 mm	0	0
2 inch	50 mm	0	0-20
1 1/2 inch	37.5 mm	0-20	0-20
1 inch	25.0 mm	0-20	5-20
3/4 inch	19.0 mm	5-20	5-20
1/2 inch	12.5 mm	5-20	5-20
3/8 inch	9.5 mm	5-20	5-20
No. 4	4.75 mm	5-20	5-20
No. 8	2.36 mm	5-20	5-20
No. 16	1.18 mm	5-20	5-20
No. 30	600 µm	5-20	5-20
No. 50	300 µm	0-20	0-20
No. 100	150 µm	0-20	0-20
No. 200	75 µm	0-5	0-5

Note: For the sieves in the shaded areas, the sum of any two adjacent sieves shall be a minimum of 12 percent of the total combined aggregates.

Each type of aggregate to be used in the proposed mixture shall be sampled and tested individually. The percent of total combined aggregates retained shall be determined mathematically based on the proportions of the combined aggregate blend. All gradation calculations shall be based on percent of dry weight (mass).

**SECTION 1005 – JOINT MATERIALS FOR PAVEMENTS AND STRUCTURES:**

**Subsection 1005.04 – Combination Joint Former/Sealer (11/05), Pages 782 and 783.**

Delete Heading (a) and substitute the following.

(a) Description: This joint former/sealer is intended for use in simultaneously forming and sealing a weakened plane in portland cement concrete pavements.

The material shall consist of an elastomeric strip permanently bonded either mechanically or chemically at the top of each of two rigid plastic side frames and covered with a removable plastic top cap. Side frames shall be of such configuration that when the sealer is inserted into plastic concrete and vibrated, a permanent bond forms between side frames and concrete.

Delete Heading (b)(1) and substitute the following.

(1) Elastomer: The elastomer strip portion of the material shall be manufactured from vulcanized elastomeric compound using polymerized chloroprene or thermoplastic vulcanizate as the base polymer, and shall comply with the following requirements:

<u>Property</u>	<u>ASTM Test Method</u>	<u>Requirements</u>	
		<u>Polymerized Chloroprene</u>	<u>Thermoplastic Vulcanizate</u>
Tensile Strength, kPa, Min.	D 412	12,400	7,400
Elongation at Break, % Min.	D 412	200	400
Hardness, Shore A	D 2240	65 ± 10	65 ± 10
Properties after Aging, 70 h @ 100°C	D 573		
Tensile Strength, % Loss, Max.		20	20
Elongation, % loss, Max.		25	25
Hardness, pts. increase, Max.		10	10
Ozone Resistance, 20% strain or bentloop, 300 pphm in air, 70 h @ 40°C	D 1149	no cracks	no cracks
Oil Swell, IRM 903, 70 h @ 100°C, wt change, % Max.	D 471	45	75

Delete Headings (b)(2) and (b)(3) and substitute the following:

(2) Bond of Elastomer to Plastic: The force required to shear the elastomer from the plastic shall be a minimum of 5.0 pounds per linear inch (90 g/mm) of sealer when tested in accordance with DOTD TR 636.

(3) Bond of Plastic to Cement Mortar: This bond will be evaluated and shall meet the following requirements:

The force required to separate the cement mortar from the plastic shall be a minimum of 5.0 pounds per linear inch (90 g/mm) of sealer when tested in accordance with DOTD TR 636.

**SECTION 1006 – CONCRETE AND PLASTIC PIPE:**

Subsection 1006.09 – Plastic Yard Drain Pipe (06/07), Page 789.

Delete the contents of Subheading (a)(3), Ribbed Polyvinyl Chloride Pipe (RPVCP) and substitute the following.

Ribbed Polyvinyl Chloride Pipe (RPVCP): Ribbed Polyvinyl Chloride Pipe shall comply with ASTM F 794, Series 46 or ASTM F 949 (46 psi).

**SECTION 1013 – METALS:**

Subsection 1013.09 – Steel Piles (08/06) Page 822.

Delete the title and references to “Steel Piles” in this subsection and substitute “Steel H Piles”.

**SECTION 1015 – SIGNS AND PAVEMENT MARKINGS:**

Subsection 1015.04 – Sign Panels (05/07), Pages 832 and 833.

Delete the contents of Heading (a), Permanent Sign Panels and substitute the following.

**Supplemental Specifications (May 2009)**  
**Page 26 of 32**

(a) Permanent Sign Panels: Flat panels shall be aluminum sheets or plates complying with ASTM B 209, Alloy 6061-T6 or Alloy 5052-H38. Extruded aluminum panels shall comply with ASTM B 221 (ASTM B 221M), Alloy 6063-T6 and after fabrication, have a flatness equal to or less than 0.031 inch per foot of length and 0.004 inch per inch of width.

Subsection 1015.05 - Reflective Sheeting (04/08), Pages 833 – 838.

Delete the contents of this subsection and substitute the following.

**1015.05 REFLECTIVE SHEETING.**

(a) Permanent and Temporary Standard Sheeting: Reflective sheeting shall be one of the following standard types as specified on the plans and complying with ASTM D 4956 except as modified herein. Permanent warning, regulatory, guide and supplemental guide sign sheeting shall meet the requirements of ASTM D 4956 Type X. Reflective sheeting for temporary signs and devices shall meet the requirements of ASTM D 4956 Type III except as noted in Subsection 1015.05(f). Reflective sheeting shall be an approved product listed in QPL 13.

Type III - A high-intensity retroreflective sheeting that is typically encapsulated glass-bead retroreflective material.

Type VI - An elastomeric high-intensity retroreflective sheeting without adhesive. This sheeting is typically a vinyl microprismatic retroreflective material.

Type X - A super high-intensity retroreflective sheeting having highest retroreflectivity characteristics at medium distances. This sheeting is typically an unmetalized microprismatic retroreflective element material.

(b) Fluorescent Pink Retroreflective Sheeting: Signs for temporary control of traffic through incident management areas shall be Type VI fluorescent pink retroreflective sheeting and shall comply with the MUTCD. Temporary traffic control signs for incident management shall be placed to notify motorists of upcoming incidents on the roadway, and shall be removed from public view once the incident has been managed. Physical properties shall comply with ASTM D 4956. Photometric properties shall be as follows.

(1) Retroreflectivity: Minimum Coefficients of Retroreflection shall be as specified in Table 1015-1.

Table 1015-1  
Coefficients of Retroreflection for Fluorescent Pink Sheeting<sup>1</sup>

Observation Angle, degrees	Entrance Angle, degrees	Fluorescent Pink
0.2	-4	100
0.2	+30	40
0.5	-4	40
0.5	+30	15

<sup>1</sup>Minimum Coefficient of Retroreflection ( $R_A$ ) ( $cd\ lx^{-1}\ m^{-2}$ )

(2) Color and Daytime Luminance: Color Chromaticity Coordinates and Daytime Luminance Factors shall be as specified in Table 1015-2.

Table 1015-2  
Fluorescent Pink Color Specifications Limits (Daytime)

Chromaticity Coordinates (corner points) <sup>1</sup>								Luminance Factor, min.
1		2		3		4		Y%
x	y	x	y	x	y	x	y	25
0.450	0.270	0.590	0.350	0.644	0.290	0.536	0.230	

<sup>1</sup>The four pairs of chromaticity coordinates measured with CIE 2° Standard Observer and 45/0 (0/45) geometry and CIE D65 Standard Illuminant.

(c) Adhesive Classes: The adhesive required for retroreflective sheeting shall be Class 1 (pressure sensitive) as specified in ASTM D 4956.

(d) Accelerated Weathering: Reflective sheeting, when processed, applied and cleaned in accordance with the manufacturer's recommendations shall perform in accordance with the accelerated weathering standards in Table 1015-3.

Table 1015-3  
Accelerated Weathering Standards<sup>1</sup>

Type	Retroreflectivity <sup>2</sup>				Colorfastness <sup>3</sup>	
	Orange/ Fluorescent Orange	80 <sup>4</sup>	All colors, except orange/Fluorescent Orange	80 <sup>4</sup>	Orange/ Fluorescent Orange	All colors, except orange/Fluorescent Orange
III	1 year	80 <sup>4</sup>	3 years	80 <sup>4</sup>	1 year	3 years
III (for drums)	1 year	80 <sup>4</sup>	1 year	80 <sup>4</sup>	1 year	1 year
VI	1/2 year	50 <sup>5</sup>	1/2 year	50 <sup>5</sup>	1/2 year	1/2 year
X	1 year	80 <sup>6</sup>	3 years	80 <sup>6</sup>	1 year	3 years

<sup>1</sup>At an angle of 45° from the horizontal and facing south in accordance with ASTM G 7 at an approved test facility in Louisiana or South Florida.

<sup>2</sup>Percent retained retroreflectivity of referenced table after the outdoor test exposure time specified.

<sup>3</sup>Colors shall conform to the color specification limits of ASTM D 4956 after the outdoor test exposure time specified.

<sup>4</sup>ASTM D 4956, Table 8.

<sup>5</sup>ASTM D 4956, Table 13.

<sup>6</sup>ASTM D 4956, Table 4.

(e) Expected Sign Life Data and Performance: The sheeting manufacturer shall supply expected retroreflectivity service life curves for each of the following sign sheeting colors: white, green, blue, brown, red, and yellow. The service life curves shall be plots of the 95 percent expected life plotted on an x-y graph with life years on the x-axis and retroreflectivity on the y-axis. The expected life shall account for worst case installations, equivalent to an installation in South Louisiana with the sign facing to the South. The sheeting manufacturer shall also supply a table of expected life values taken from the service life curves for Revision Number 2 to the 2003 Edition of the MUTCD minimum reflectivity requirements published in the Federal Register on December 21, 2007. Reflective sheeting for signs, when processed, applied and cleaned in accordance with the manufacturer's recommendations shall perform outdoors in accordance with the performance standards in Table 1015-4.



Table 1015-4  
Reflective Sheeting Performance Standards

Type	Retroreflectivity <sup>1</sup> -- Durability <sup>2</sup>				Colorfastness <sup>3</sup>
	Orange/ Fluorescent Orange		All colors, except orange/Fluorescent Orange		
III	3 years	80 <sup>4</sup>	10 years	80 <sup>4</sup>	3 years
X	3 years	80 <sup>5</sup>	7years	80 <sup>5</sup>	3 years

<sup>1</sup>Percent retained retroreflectivity of referenced table after installation and the field exposure time specified.

<sup>2</sup>All sheeting shall maintain its structural integrity, adhesion and functionality after installation and the field exposure time specified.

<sup>3</sup>All colors shall conform to the color specification limits of ASTM D 4956 after installation and the field exposure time specified.

<sup>4</sup>ASTM D4956, Table 8.

<sup>5</sup>ASTM D 4956, Table 4.

(f) Temporary Signs, Barricades, Channelizing Devices, Drums and Cones: Reflective sheeting for temporary signs, barricades and channelizing devices, shall meet the requirements of ASTM D 4956, Type III except that temporary warning construction signs used on the mainline of freeways and expressways shall be fluorescent orange and meet the requirements of ASTM D 4956, Type X.

Reflective sheeting for vertical panels shall meet the requirements of ASTM D 4956, Type III.

Reflective sheeting for drums shall be a minimum of 6 inches (150 mm) wide and shall meet the requirements of ASTM D 4956, Type III, and the Supplementary Requirement S2 for Reboundable Sheeting as specified in ASTM D 4956. Reflective sheeting for traffic cone collars shall meet the requirements of ASTM D 4956, Type III or Type VI.

(g) Sheeting Guaranty. The contractor shall provide the Department with a guaranty from the sheeting manufacturer stating that if the retroreflective sheeting fails to comply with the performance requirements of this subsection, the sheeting manufacturer shall do the following:

Table 1015-5  
 Manufacturer's Guaranty-Reflective Sheeting

Type	Manufacturer shall restore the sign face in its field location to its original effectiveness at no cost to the Department if failure occurs during the time period <sup>1</sup> as specified below		Manufacturer shall replace the sheeting required to restore the sign face to its original effectiveness at no cost to the Department if failure occurs during the time period <sup>1</sup> as specified below
	Orange/Fluorescent Orange	All colors, except orange/Fluorescent Orange	All colors, except orange/Fluorescent Orange
III	<3 years	<7 years	7-10 years
X	<3 years	<5 years	5-7 years

<sup>1</sup> From the date of sign installation.

Replacement sheeting for sign faces, material, and labor shall carry the unexpired guaranty of the sheeting for which it replaces.

The sign fabricator shall be responsible for dating all signs with the month and year of fabrication at the time of sign fabrication. This date shall constitute the start of the guaranty obligation period.

Subsection 1015.11 - Preformed Plastic Pavement Marking Tape (06/07), Pages 842 – 844.

Delete the contents of this subsection and substitute the following.

**1015.11 PREFORMED PLASTIC PAVEMENT MARKING TAPE.**

(a) General: Preformed plastic pavement marking tape shall be approved products listed on QPL 64 and shall comply with ASTM D4505 Retroreflectivity Level I or Level II, or DOTD Intersection Grade (as specified below), except as modified herein. The marking tape shall be Class 2 or 3. The type and color shall be in accordance with the plans and the MUTCD.

(b) Thickness: All preformed plastic pavement marking tape shall have a minimum overall thickness of 0.060 inches (1.5 mm) when tested without the adhesive.

(c) Friction Resistance: The surface of the Retroreflectivity Level II preformed plastic pavement marking tape shall provide a minimum frictional resistance value of 35 British Polish Number (BPN) when tested according to ASTM E303. The surface of the Retroreflectivity Level I and DOTD Intersection Grade preformed plastic pavement marking tape shall provide a minimum frictional resistance value of 45 BPN when tested according to ASTM E303. Values for the Retroreflectivity Level I material with a raised surface pattern as defined in ASTM D4505 are calculated by averaging values taken at downweb and at a 45 degrees angle from downweb.

(d) **Retroreflective Requirements:** The preformed plastic pavement marking tape shall have the minimum initial specific luminance values shown in Table 1015-7 when measured in accordance with ASTM D 4061.

Table 1015-7  
 Specific Luminance of Preformed Plastic Tape

Type	Observation Angle, degrees	Entrance Angle, degrees	Specific Luminance (mcd/sq m/lx)	
			White	Yellow
Retroreflectivity Level I	1.05	88.76	500	300
DOTD Intersection Grade	1.05	88.76	375	250
Retroreflectivity Level II	1.05	88.76	250	175

(e) **Durability Requirements:** The DOTD Intersection Grade preformed plastic pavement marking tape shall show no appreciable fading, lifting or shrinkage for a least 12 months after placement when placed in accordance with the manufacturer's recommended procedures on pavement surfaces having a daily traffic count not to exceed 15,000 ADT per lane.

The Retroreflectivity Level I preformed plastic pavement marking tape shall show no appreciable fading, lifting or shrinkage for a least 4 years after placement for longitudinal lines and at least 2 years after placement for symbols and legends.

The Retroreflectivity Level I preformed plastic pavement marking tape shall also retain the following reflectance values for the time period detailed in Table 1015-8.

Table 1015-8  
 Retained Specific Luminance for Retroreflectivity Level I  
 Preformed Plastic Pavement Marking Tape

Time	Observation Angle, degrees	Entrance Angle, degrees	Specific Luminance (mcd/sq m/lx)	
			White	Yellow
1 year	1.05	88.76	400	240
4 years (2 years for symbols and legend)	1.05	88.76	100	100

(f) **Plastic Pavement Marking Tape Guaranty (DOTD Intersection Grade and Retroreflectivity Level I):** If the plastic pavement marking tape fails to comply with the performance and durability requirements of this subsection within 12 months for DOTD Intersection Grade and 4 years for Retroreflectivity Level I, the manufacturer shall replace the plastic pavement marking material at no cost to the Department.

**SECTION 1020 – TRAFFIC SIGNALS:**

Subsection 1020.01 – Traffic Signal Heads (06/07), Pages 873 – 884.

Delete the contents of Heading (a), General Requirements and substitute the following.

**Supplemental Specifications (May 2009)**  
**Page 32 of 32**

(a) General Requirements: Traffic signal sections, beacon sections and pedestrian signal sections shall be of the adjustable type. Materials and construction of each section shall be the same.

Signals shall be constructed for either 8 or 12-inch (200 mm or 300 mm) lens in accordance with the plans. Signal sections shall have three to five sections per face and beacon sections have only one section per face. Signal sections and associated brackets shall be finished inside and out with two coats of high grade dark olive green enamel, color number 14056 according to Federal Standard No. 595b with each coat independently baked. Visors shall be coated green on the outside and black on the inside. Edges shall be deburred and smooth with no sharp edges.

Subsection 1020.04 – Poles for Traffic Signal Systems (06/07), Pages 890 – 894.

Delete the sixth paragraph of Heading (a), Pedestal Support Signal Poles, and substitute the following.

Pedestals shall be finished with at least one coat of rustproofing primer, applied to a clean surface and one coat of dark olive green enamel, color number 14056 according to Federal Standard No. 595.

TOTAL SHEETS = 30

STATE OF LOUISIANA  
DEPARTMENT OF TRANSPORTATION & DEVELOPMENT

STATE PROJECT	PARISH	SHEET NO.
737-96-0076	DISTRICTWIDE	1

PLANS OF PROPOSED  
STATE HIGHWAY

STATE PROJECT NO. 737-96-0076

TREE AND STUMP REMOVAL IN DISTRICT 61  
DISTRICTWIDE

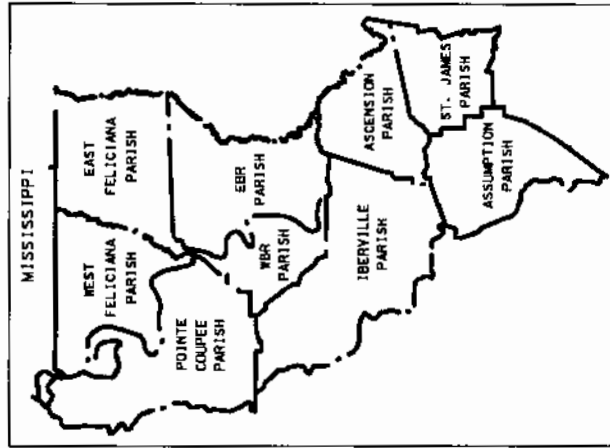
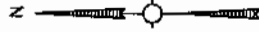

TYPE CONSTRUCTION: TREE AND STUMP REMOVAL

DATE	REVISION	DATE	RECOMMENDED	DATE	APPROVED

RECOMMENDED FOR APPROVAL

*[Signature]*  
PROGRAM DESIGNER  
*[Signature]*  
DISTRICT ADMINISTRATOR

DATE  
6/2/09

APPROVED

THE 2006 LOUISIANA D.O.T.D. STANDARD SPECIFICATIONS FOR ROADS AND BRIDGES AS AMENDED BY THE PROJECT SPECIFICATIONS SHALL GOVERN ON THIS PROJECT.

STATE PROJECT NO.	PARISH	SHEET NO.
737-96-0076	DISTRICTWIDE	2

**TABLE OF CONTENTS**

<b>SHEET NO.(S)</b>	<b>DESCRIPTION</b>
1	TITLE SHEET
2	TABLE OF CONTENTS
3-6	TREES TO BE REMOVED
7-18	PICTURES OF TREES TO BE REMOVED
19	SUMMARY OF ESTIMATED QUANTITIES
20-25	PARISH MAPS
26-30	TEMPORARY TRAFFIC CONTROL SHEETS

		STATE PROJECT NO.		PARISH		SHEET NO.			
		737-96-0076		DISTRICTWIDE		3			
TREES TO BE REMOVED (SHEET 1 OF 4)									
LOCATION #	ROUTE	PARISH	CONTROL SECTION	LOGMILE	DESCRIPTION OF LOCATION	TREES		DIST. FROM EDGE OF TRAVEL LANE	NOTE
						# OF TREES	DIAMETER		
1	LA 1	ASSUMPTION	064-04	4.88	APPROXIMATELY 1/4 MILE NORTH OF LA 400 ON THE WEST SIDE	1	34"	OAK	PICTURE NOT AVAILABLE
2	LA 1014	ASSUMPTION	804-03	0.07	APPROXIMATELY 0.07 MILES FROM LA 308	1	80"	PINE	PICTURE NOT AVAILABLE
3	LA 1003	ASSUMPTION	804-18	0.02	APPROXIMATELY 0.20 MILES FROM LA 1 ON THE SOUTH SIDE	1	62"	WILLOW	PICTURE NOT AVAILABLE
4	LA 1003	ASSUMPTION	804-18	0.02	APPROXIMATELY 0.20 MILES FROM LA 1 ON THE SOUTH SIDE	1	67"	WILLOW	PICTURE NOT AVAILABLE
5	LA 1003	ASSUMPTION	804-18	0.02	APPROXIMATELY 0.20 MILES FROM LA 1 ON THE SOUTH SIDE	1	79"	WILLOW	PICTURE NOT AVAILABLE
6	LA 422	EAST FELICIANA	819-02	6.50	2.4 MILES WEST OF LA 67 ON THE SOUTH SIDE	1	36"	OAK	20'
7	LA 957	EAST FELICIANA	819-15	0.60	0.60 MILES NORTH OF LA 412	1	36"	PINE	17'

F-3

**TREES TO BE REMOVED**  
(SHEET 2 OF 4)

LOCATION #	ROUTE	PARISH	CONTROL SECTION	LOGMILE	DESCRIPTION OF LOCATION	TREES			DIST. FROM EDGE OF TRAVEL LANE	NOTE
						# OF TREES	DIAMETER	TYPE		
8	LA 77	IBERVILLE	219-02	14.82	15' FROM THE CENTER LINE	1	36"	PECAN		PICTURE NOT AVAILABLE
9	LA 77	IBERVILLE	219-03	16.02	15' FROM THE CENTER LINE	1	36"	PECAN		PICTURE NOT AVAILABLE
10	LA 3066	IBERVILLE	230-01	2.00	59265 BAYOU ROAD	1	36"	HACKBERRY		PICTURE NOT AVAILABLE
11	LA 993	IBERVILLE	824-04	5.81	23' FROM THE CENTER LINE	1	432"	PECAN		PICTURE NOT AVAILABLE
12	LA 405	IBERVILLE	824-06	5.50	75' FROM THE CENTER LINE	1	288"	PECAN		PICTURE NOT AVAILABLE
13	LA 76	IBERVILLE	824-12	1.21	23' FROM THE CENTER LINE	1	60"	OAK		PICTURE NOT AVAILABLE
14	LA 76	IBERVILLE	824-12	2.20	33' FROM THE CENTER LINE	1	48"	OAK		PICTURE NOT AVAILABLE



STATE PROJECT NO. 737-96-0076	PARISH DISTRICTWIDE	SHEET NO. 5
----------------------------------	------------------------	----------------

**TREES TO BE REMOVED**  
(SHEET 3 OF 4)

LOCATION #	ROUTE	PARISH	CONTROL SECTION	LOGMILE	DESCRIPTION OF LOCATION	TREES			DIST. FROM EDGE OF TRAVEL LANE	NOTE
						# OF TREES	DIAMETER	TYPE		
15	LA 418	POINTE COUPEE	222-03	9.52	8170 LA 418 (0.30 MILES WEST OF LA 1)	1	46"	PECAN		
16	LA 411	POINTE COUPEE	229-04	0.20	0.20 MILES NORTH OF THE IBERVILLE PARISH LINE	1	34"	PECAN		
17	LA 81 S	POINTE COUPEE	839-08	5.09	5620 LA 81 S, BLANKS, LA (0.40 MILES SOUTHEAST OF US 190)	1	72"	OAK		
18	LA 976	POINTE COUPEE	839-21	0.30	0.30 MILES NORTH OF LA 81	1	60"	ELM		
19	US 190	WEST BATON ROUGE	008-01	3.79	2215 US 190 W	1	36"	OAK	30'	
20	LA 415	WEST BATON ROUGE	226-01	6.78	17513 N. RIVER RD.	1	48"	OAK	18'	
21	LA 415	WEST BATON ROUGE	861-01	1.70	17851 N. RIVER RD.	1	40"	SYCAMORE	26'	

F-5

STATE PROJECT NO. 737-96-0076	PARISH DISTRICTWIDE	SHEET NO. 6
----------------------------------	------------------------	----------------

**TREES TO BE REMOVED**  
(SHEET 4 OF 4)

LOCATION #	ROUTE	PARISH	CONTROL SECTION	LOGMILE	DESCRIPTION OF LOCATION	TREES			DIST. FROM EDGE OF TRAVEL LANE	NOTE
						# OF TREES	DIAMETER	TYPE		
22	LA 421	WEST FELICIANA	863-02	11.24	13290 SPILLMAN RD	1	61"	OAK	18'	
23	LA 421	WEST FELICIANA	863-02	12.00		1	60"	OAK	18'	
24	LA 965	WEST FELICIANA	863-08	1.00	0.50 MILES SOUTH OF LA 10 ON THE EAST SIDE	1	42"	OAK	14'	

F-6

STATE PROJECT	PARISH	SHEET NO
737-96-0076	DISTRICTWIDE	7

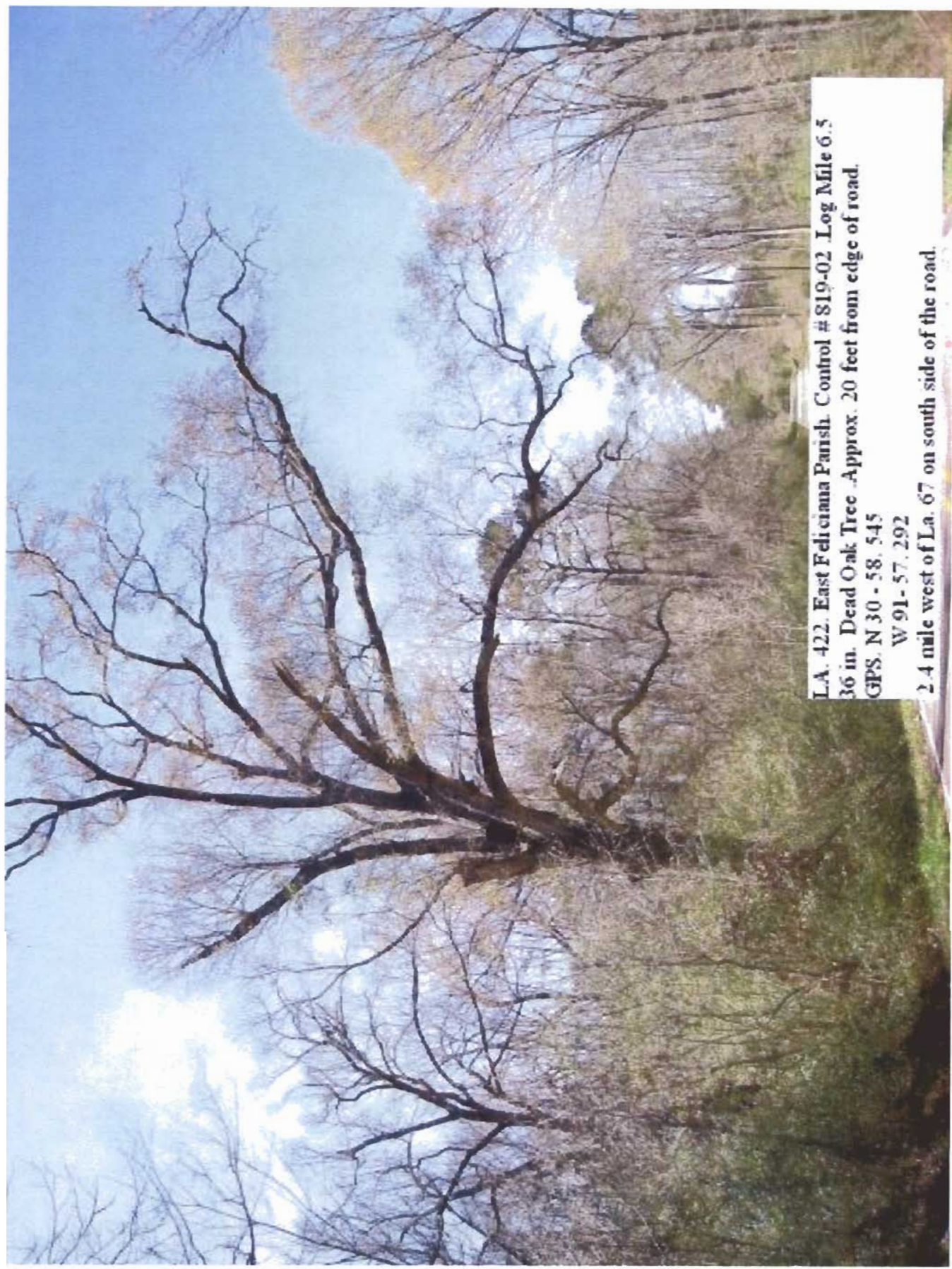

F-7

STATE PROJECT	PARISH	SHEET NO
737-96-0076	DISTRICTWIDE	8

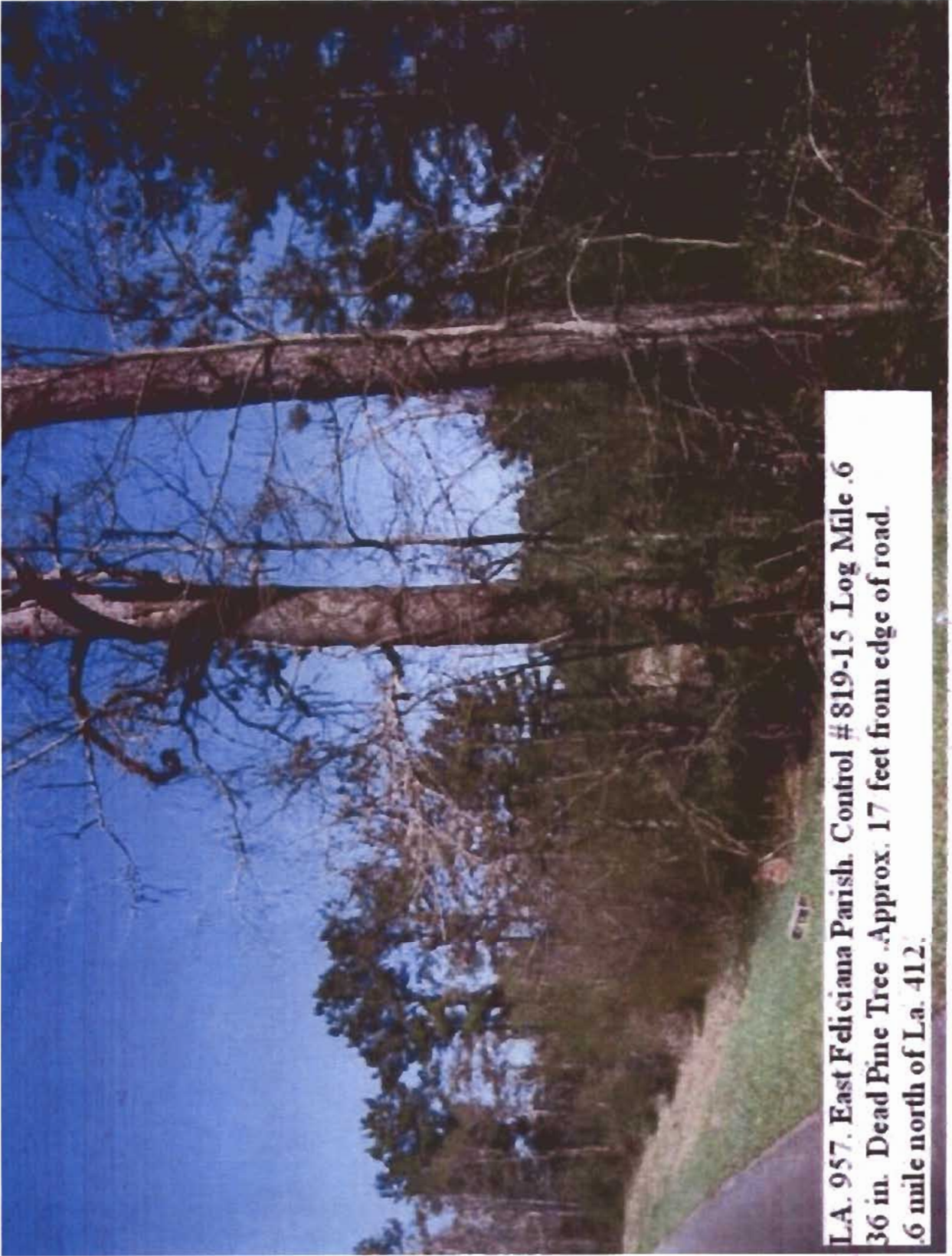

F-8

STATE PROJECT	PARISH	SHEET NO
737-96-0076	DISTRICTWIDE	9

**LA 418. Pointe Coupee Parish. Control No: 222-03. Milepost 2.0**  
**3 Tenths of a mile W. of La. 1**  
**46 inch Pecan Tree.**  
**GPS Coordinates N 30-52.170 W 091-41.871**  
**Physical Address : 8170 LA. 418**

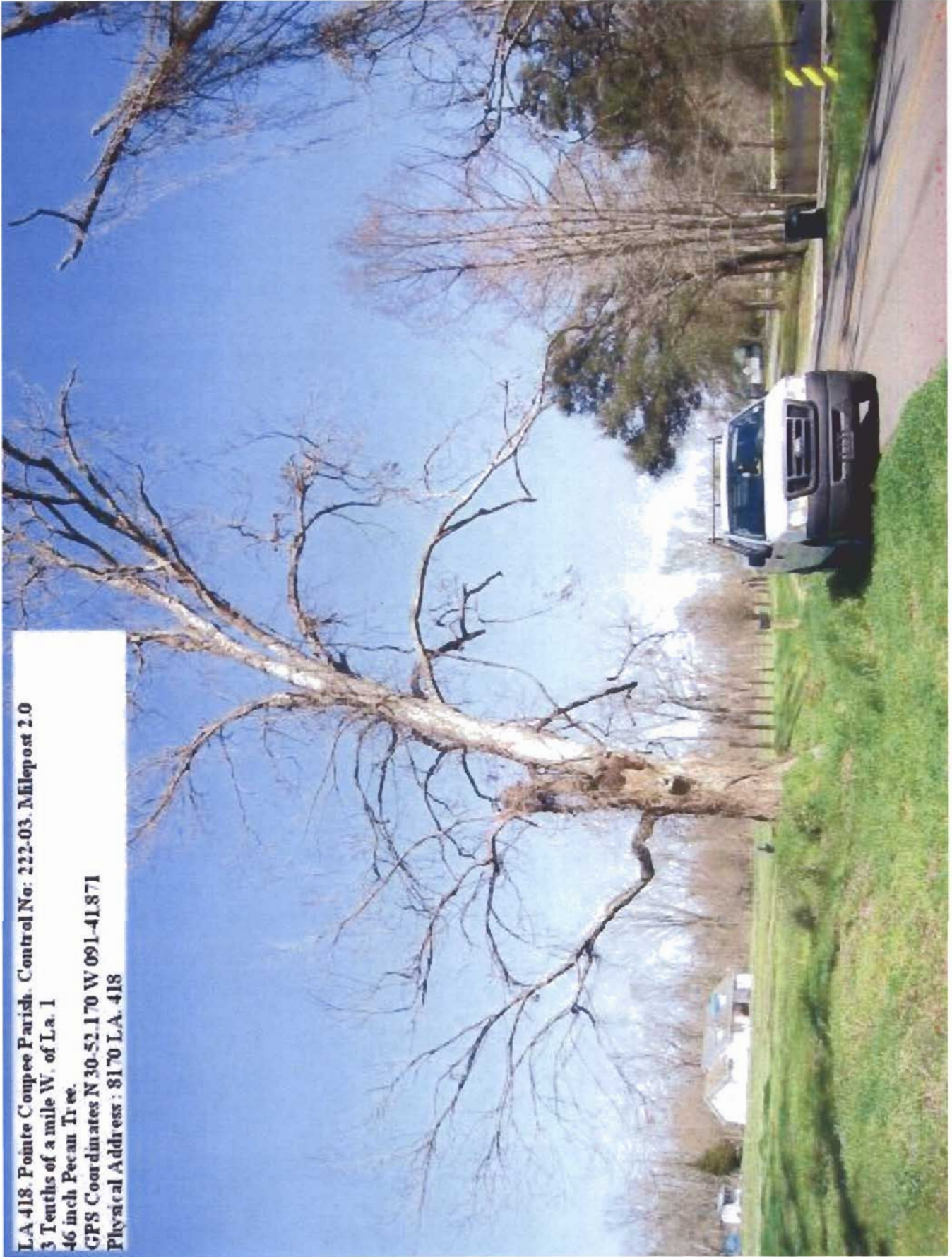

F-9

STATE PROJECT	PARISH	SHEET NO
737-96-0076	DISTRICTWIDE	10

**L.A 411. Pointe Coupee Parish. Control No: 229-04. Milepost 5.16  
2 Tenths of a mile N. of Iberville Parish Line  
34 inch Pecan Tree.  
GPS Coordinates N 30-29 932 W 091-30 863  
Physical Address : NONE**

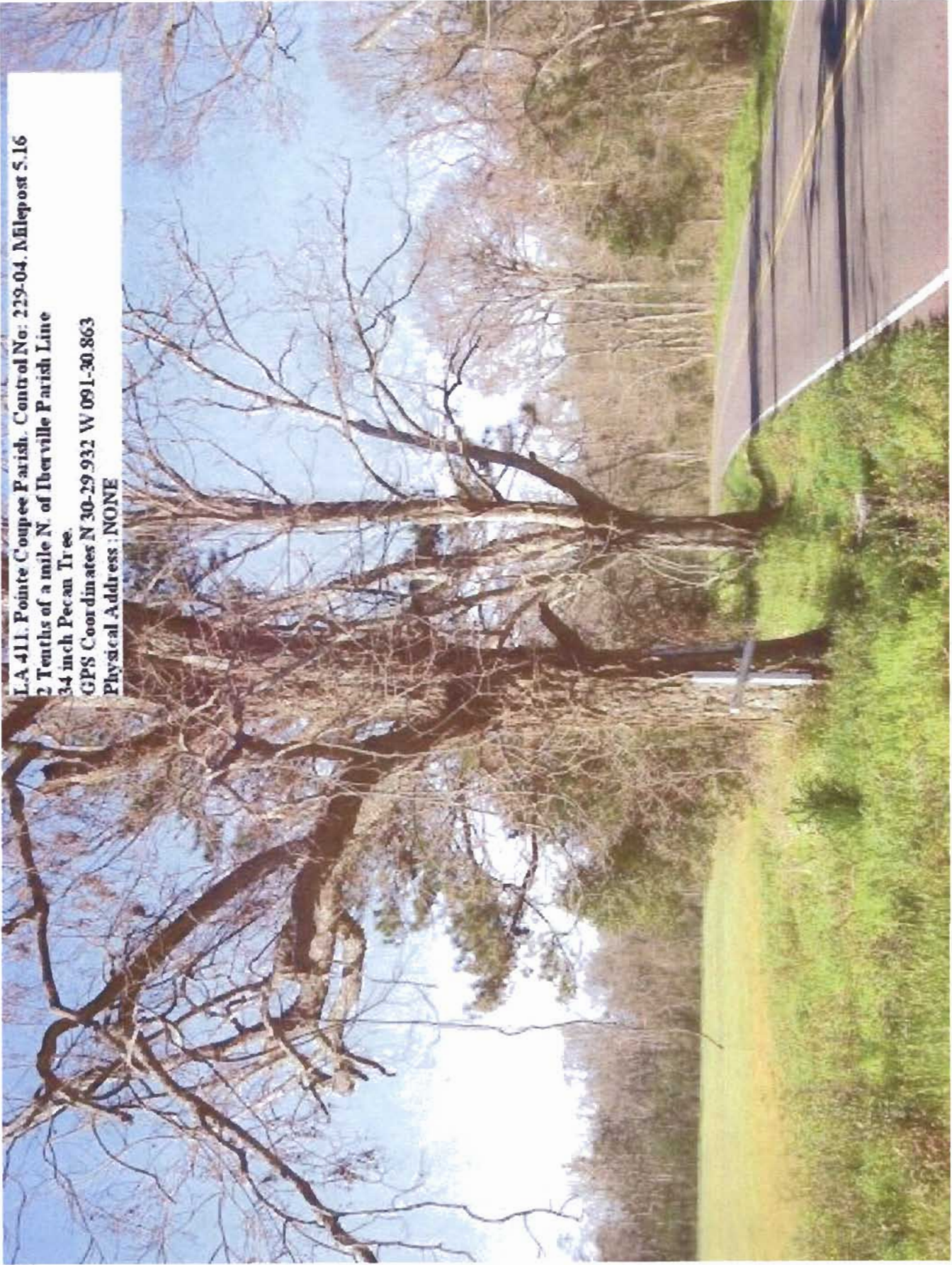

F-10

STATE PROJECT	PARISH	SHEET NO
737-96-0076	DISTRICT/WIDE	//

**L.A. 81 S. Pointe Coupee Parish, Control No: 839-08, Milepost 5.09**

**4 Tenths of a mile S.E. of US 190**

**72 inch Oak Tree, Tree has half broken off.**

**GPS Coordinates N 30.33.201 W 091-38.225**

**Physical Address : 5620 L.A. 81S, Blanks, La.**



F-11

STATE PROJECT	PARISH	SHEET NO
737-96-0076	DISTRICTWIDE	12

**L.A. 976, Pointe Coupee Parish, Control No: 839-21, Milepost .3  
3 Tenths of a mile North of La. 81.  
60 inch Elm Tree. GPS Coordinates N 30-33 082 W 091-35 968**

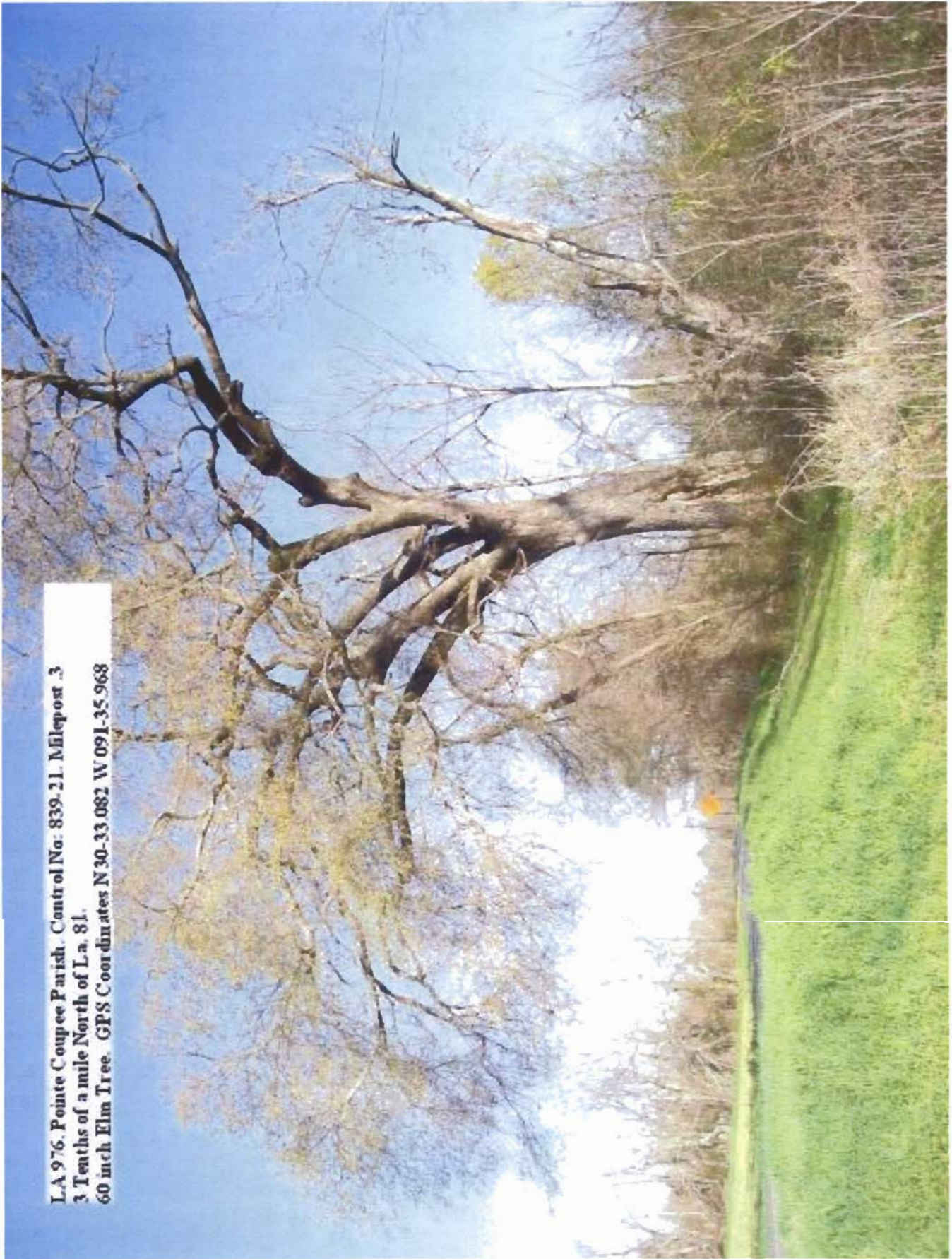

F-12



STATE PROJECT	PARISH	SHEET NO
737-96-0076	DISTRICTWIDE	13

U.S. 190 WB R. Control: 008-01, Log Mile 3.79  
36 inch Live Oak Tree. 30 feet from edge of roadway on south side of road.  
GPS: N 30 - 30.273  
W091 - 13.743  
Physical Address: 2215 US 190 W

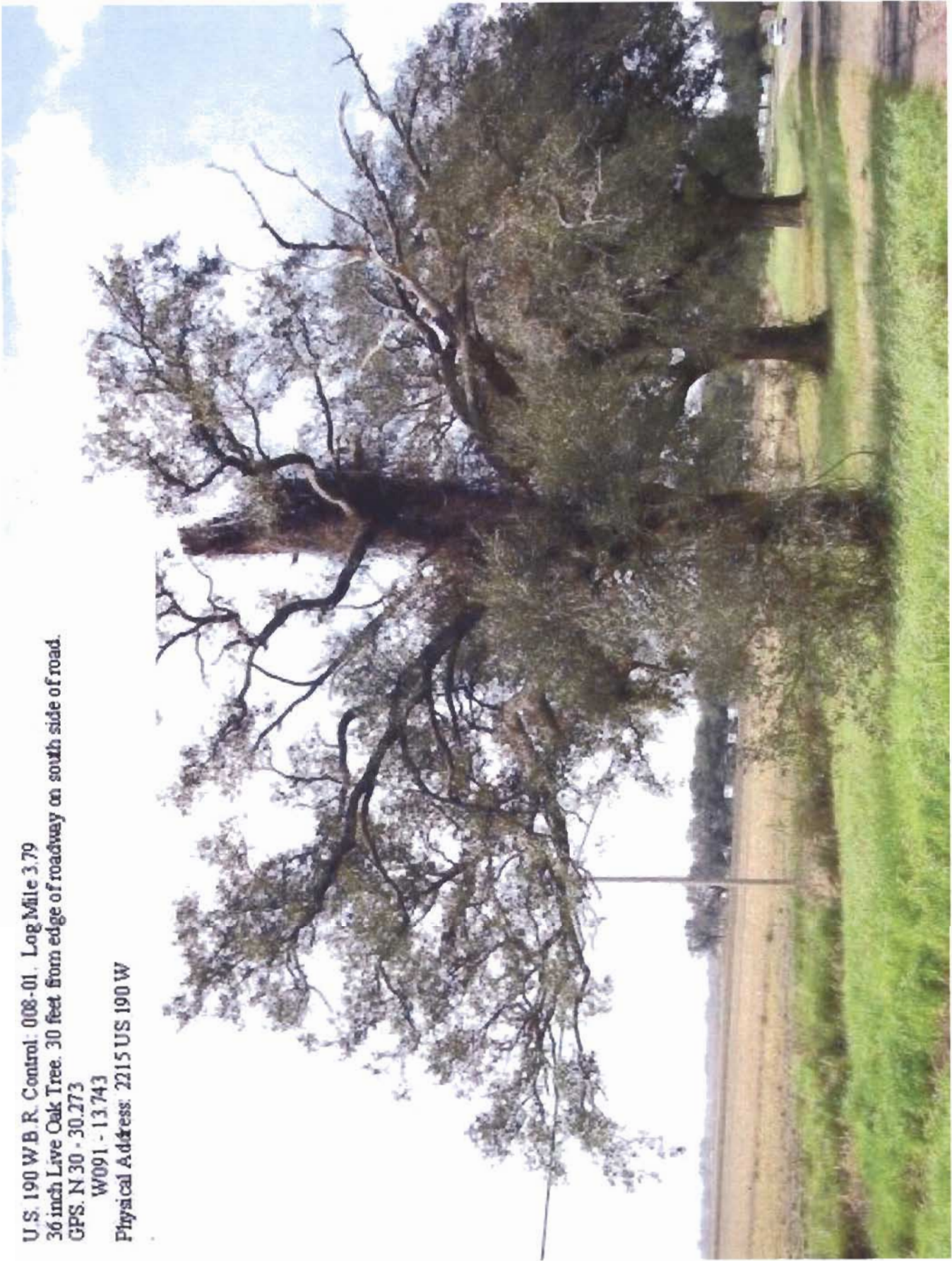

F-13

STATE PROJECT	PARISH	SHEET NO
737-96-0076	DISTRICTWIDE	14

L.A. 415 WB R. Control: 226-01. Log Mile 6.78  
48 inch Live Oak Tree. 18 feet from edge of roadway on east side of road. Hollow area in trunk

GPS: N 30 - 36.364  
W 091 - 19.185

Physical Address: 17513 N River Road



F-14

L.A. 415 W.B.R. Control: 861-01. Log Mile 1.7  
40 inch Sycamore tree. 26 feet from edge of roadway on west side of road.  
GPS: N 30 - 37.833

W091 - 18.772

Physical Address: 17851 N River Road

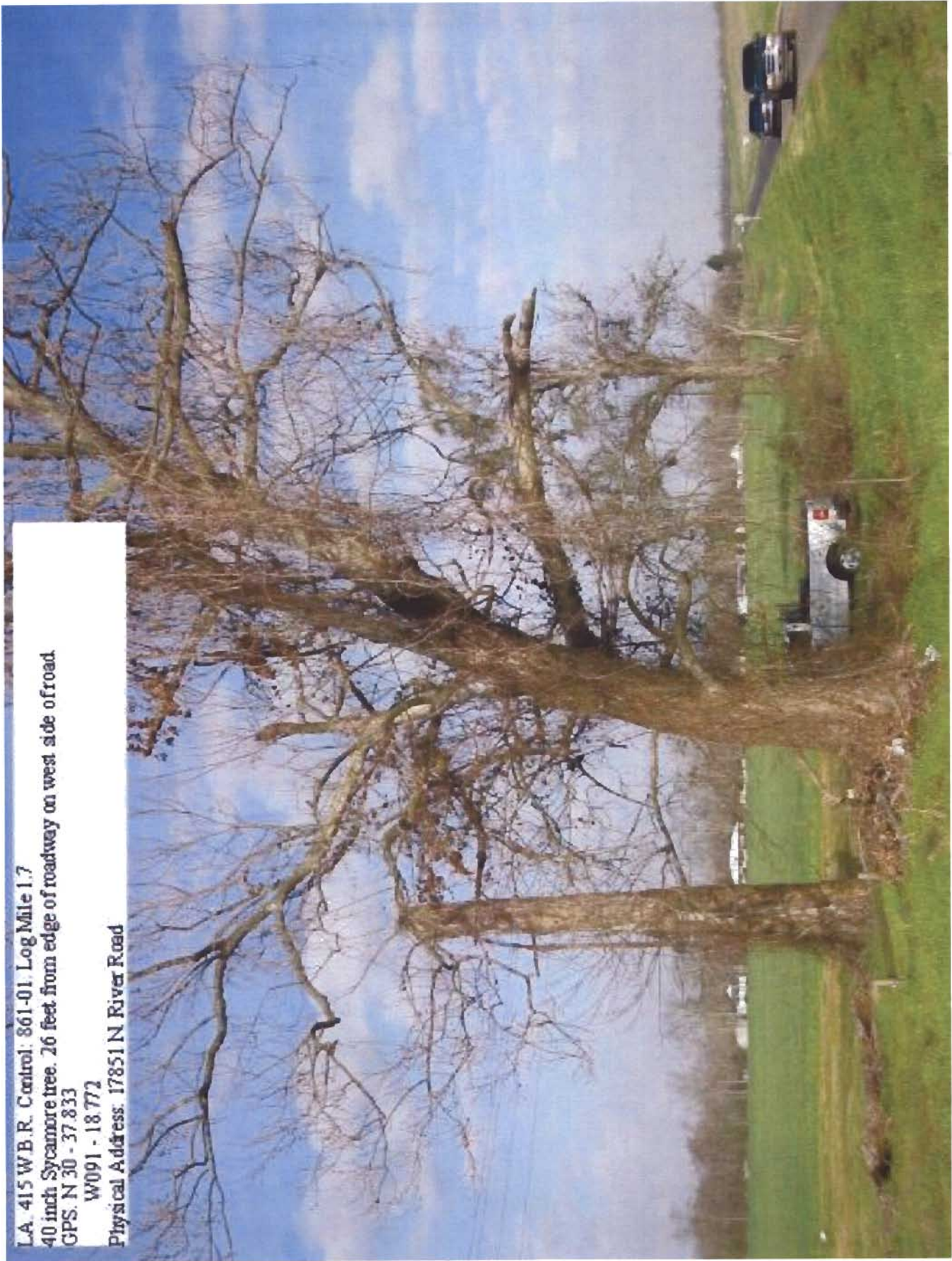

F-15

STATE PROJECT	PARISH	SHEET NO
737-96-0076	DISTRICTWIDE	16

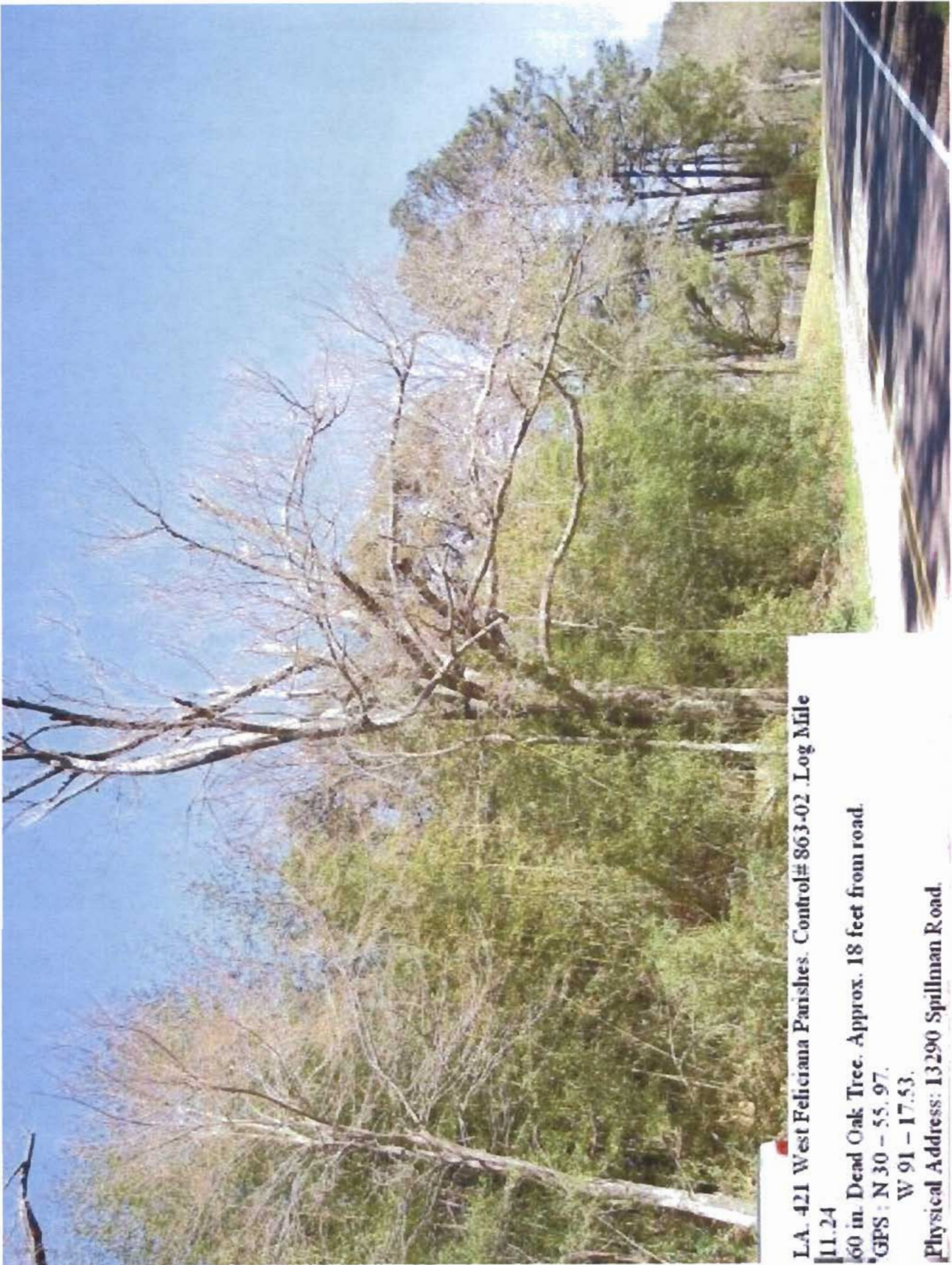

L.A. 421 West Feliciana Parishes. Control# 863-02 .Log Mile

11.24

60 in. Dead Oak Tree. Approx. 18 feet from road.

GPS : N 30 - 55.97.

W 91 - 17.53.

Physical Address: 13290 Spillman Road.

F-16

STATE PROJECT	PARISH	SHEET NO
737-96-0076	DISTRICTWIDE	17



L.A. 421 West Feliciana Parishes. Control# 863-02 . Log Mile 12.0  
60 in. Dead Oak Tree. Approx. 18 feet from road.  
GPS : N 30 - 54.39.  
W 91 - 18.28.

F-17

STATE PROJECT	PARISH	SHEET NO
737-96-0076	DISTRICTWIDE	18

L.A. 965, West Feliciana Parishes. Control# 863-08 Log Mile 1.0  
 42 in. Dead Oak Tree. Approx. 14 feet from road.  
 GPS : N 30 - 49. 671.  
 W 91 - 15.295.  
 .5 mile south of La. 10 on east side of the road.

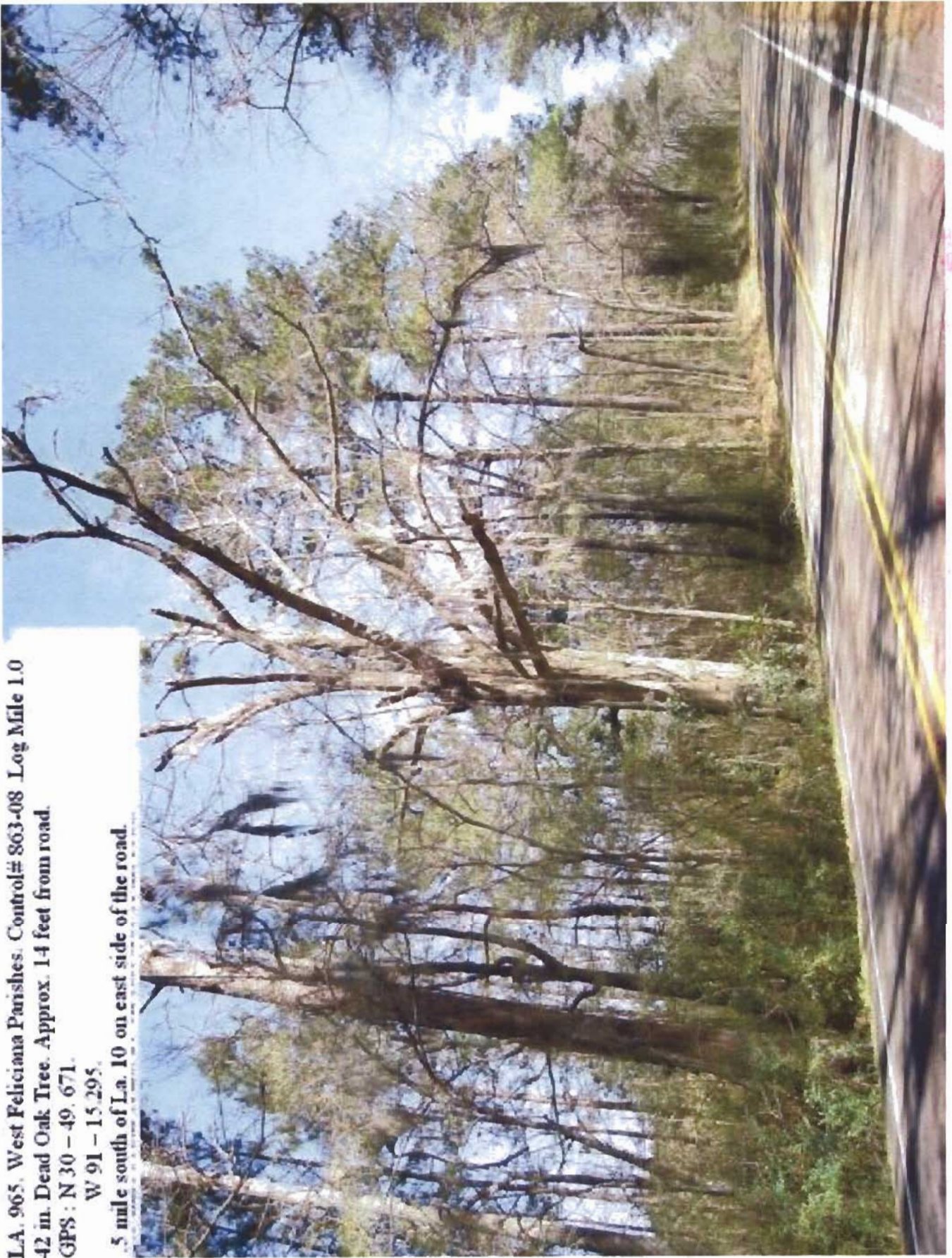

F-18

DATED 06/05/09 15:22:58

STATE PROJECT 737-96-0076	PARISH DISTRICT 61	SHEET NO. 19
------------------------------	-----------------------	-----------------

SUMMARY OF ESTIMATED QUANTITIES

ITEM NO.	ITEM	UNIT	QUANTITY S.P. NO. 737-96-0076	TOTAL QUANTITY
S-001	TREE AND STUMP REMOVAL (UNDER 36" - 36" DIAMETER)	EACH	2	
S-002	TREE AND STUMP REMOVAL (OVER 36" - 48" DIAMETER)	EACH	11	
S-003	TREE AND STUMP REMOVAL (OVER 48" DIAMETER)	EACH	11	

F-19

STATE PROJECT	PARISH	SHEET NO.
737-96-0076	DISTRICTWIDE	20

ASSUMPTION  
PARISH

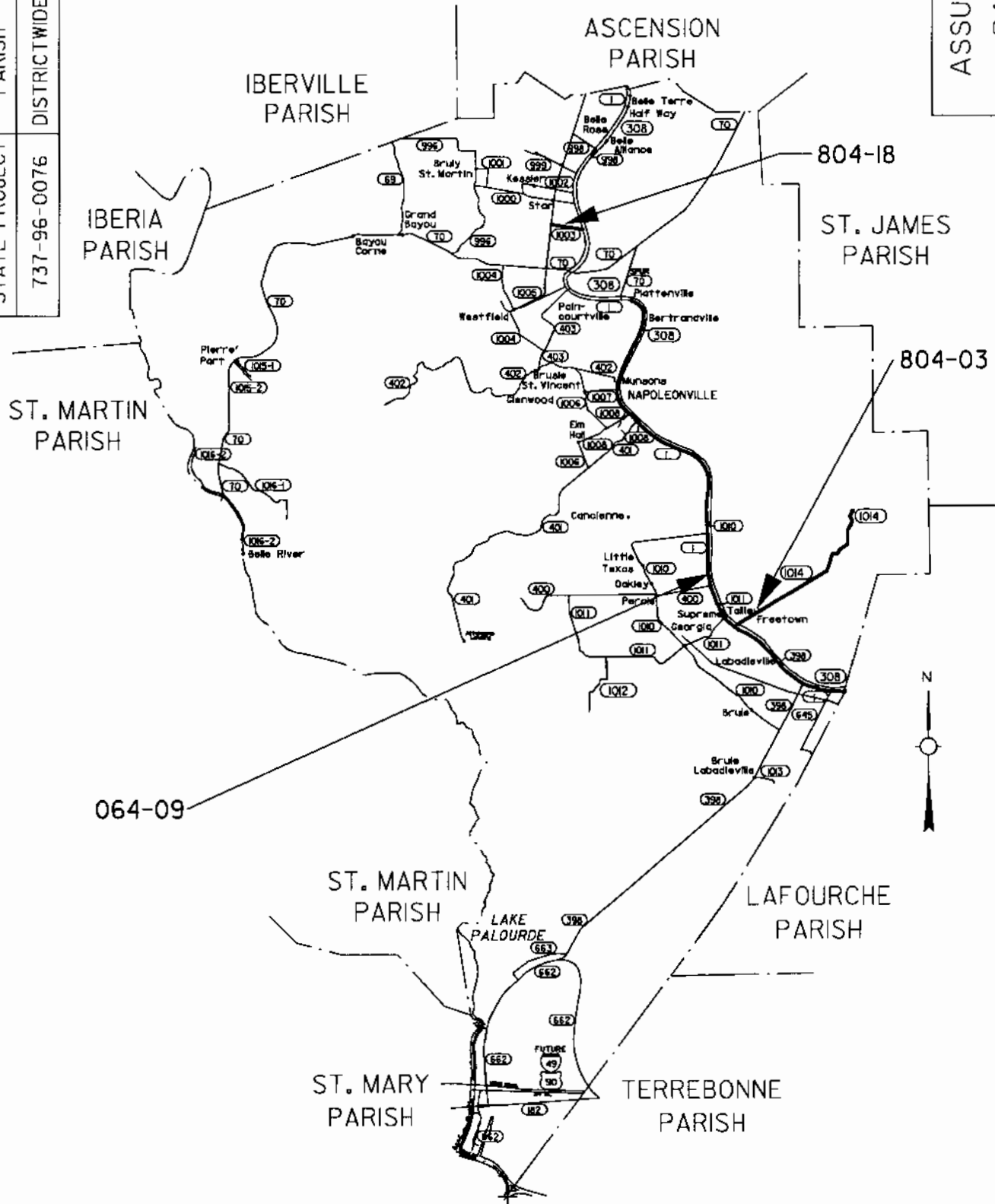



STATE PROJECT	PARISH	SHEET NO.
737-96-0076	DISTRICTWIDE	21

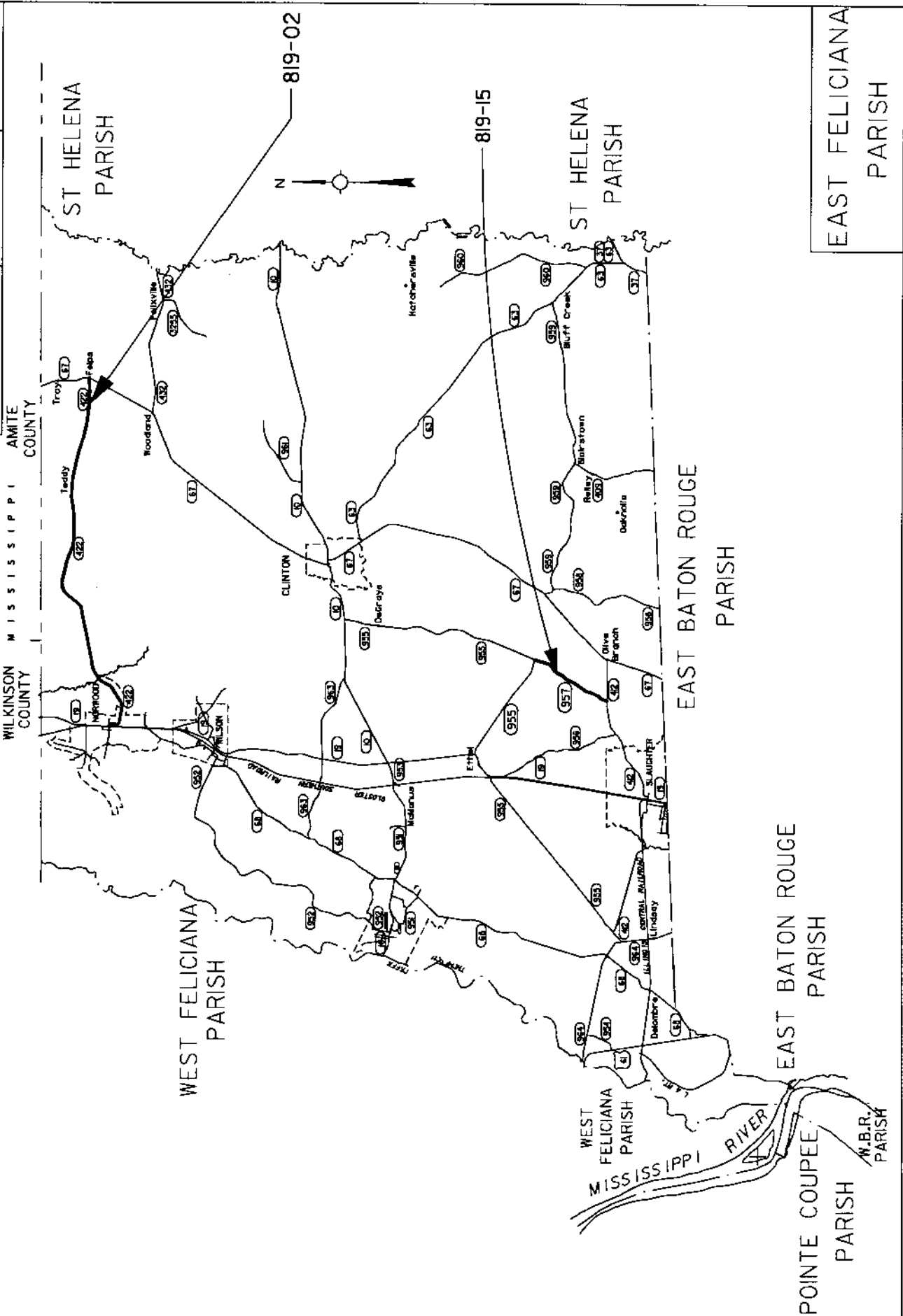

STATE PROJECT	PARISH	SHEET NO.
737-96-0076	DISTRICTWIDE	22

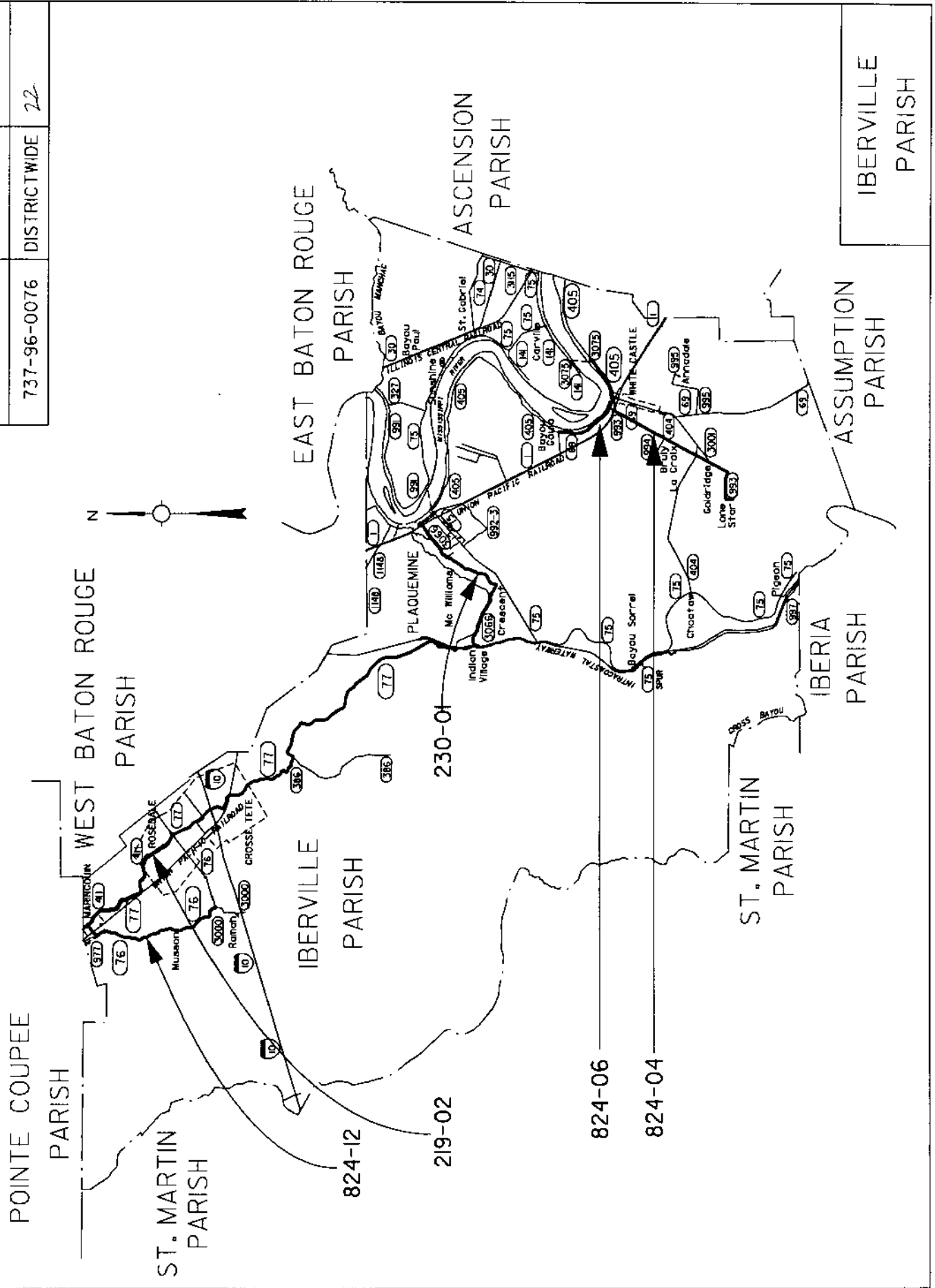

STATE PROJECT	PARISH	SHEET NO.
737-96-0076	DISTRICTWIDE	23

POINTE COUPEE  
PARISH

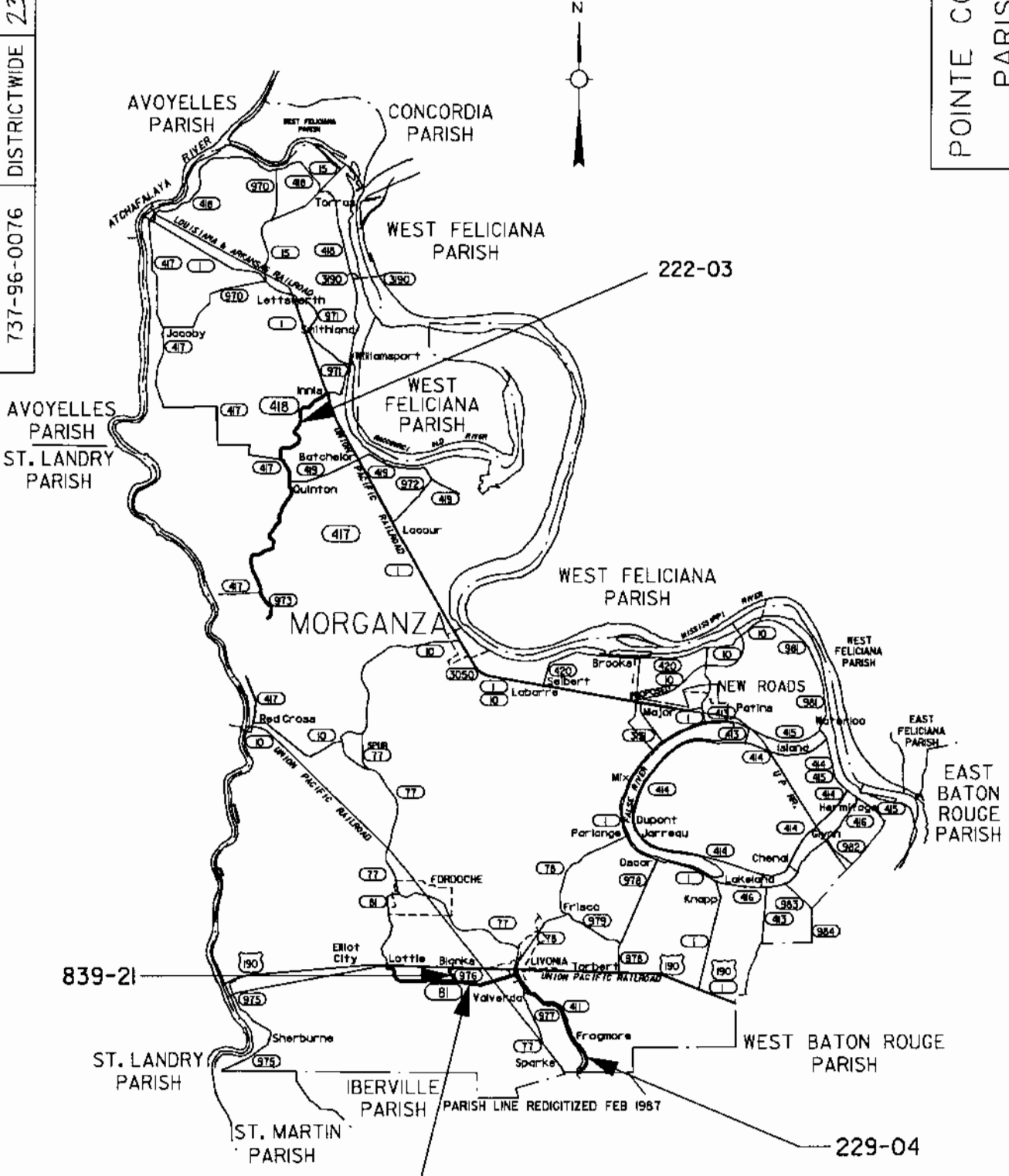

839-21

839-08

222-03

229-04

STATE PROJECT	PARISH	SHEET NO.
737-96-0076	DISTRICTWIDE	24

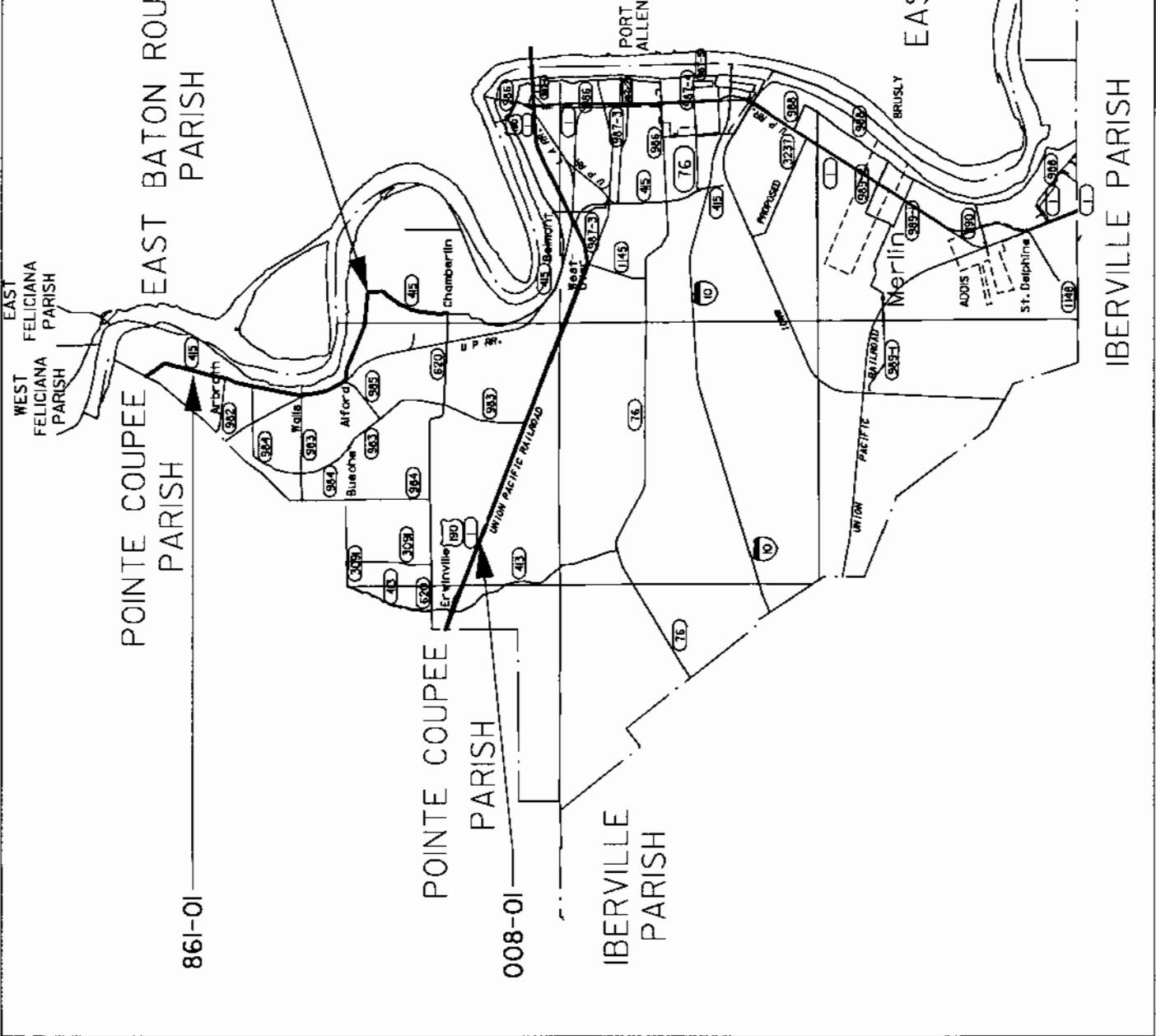

WEST BATON  
ROUGE PARISH

STATE PROJECT	PARISH	SHEET NO.
737-96-0076	DISTRICTWIDE	25

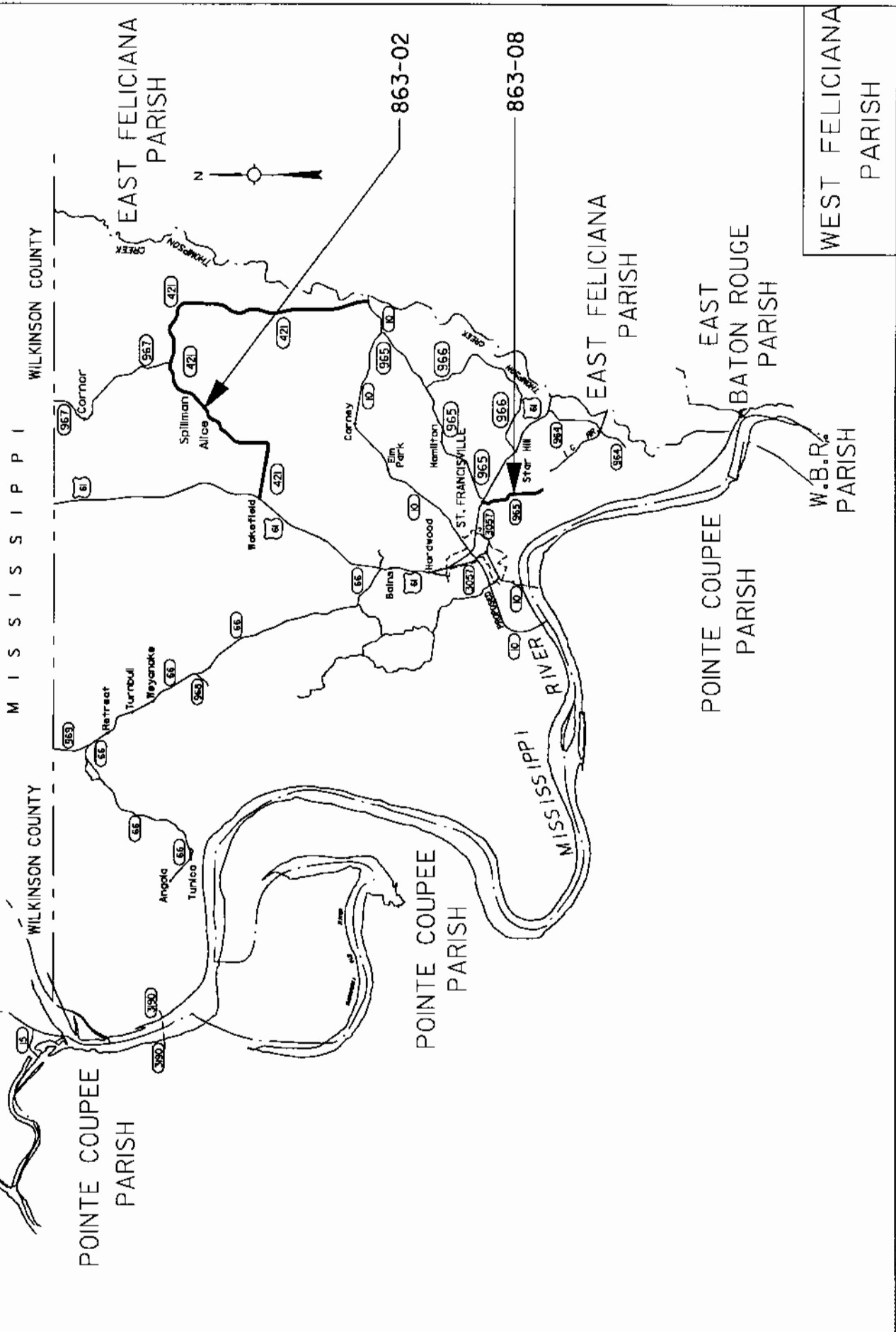

**GENERAL PROVISIONS**

- At Temporary Traffic Control Devices used shall be in accordance with the MUTCD Standard Specifications for Road and Bridge, the Manual on Uniform Traffic Control Devices (MUTCD), and shall meet the National Cooperative Highway Research Program (NCHRP) 350 for Test Level 3 requirements.
- Materials used for Temporary Traffic Control shall be in accordance with the MUTCD Standard Specifications for Road and Bridges and when applicable the DOTD Qualified Products List (QPL).
- No Temporary Traffic Control shall be erected without the approval of the Project Engineer and until work is about to begin, unless they are covered.
- No hole closures, lane shifts, detours, or detours shall occur without the authorization of the contractor for the installation, maintenance, and operation of all temporary traffic control devices called for in these plans or required by the Project Engineer for the protection of the traveling public as well as of Department and construction personnel.
- The contractor shall be responsible for the maintenance of all permanent signs and pavement markings left in place as essential to the safe movement and guidance of traffic within the project limits.
- The District Traffic Operations Engineer (DIOE) shall serve as a technical advisor to the Project Engineer for all Traffic Control matters.
- Road work near XX lanes sign shall be required on all projects equal to or greater than 2 miles and located at the beginning of the project unless otherwise noted. The distance on the sign shall be stated to the nearest whole mile. The sign shall be a minimum of 357500' unless otherwise noted.
- Warning signs used for lane closures or lane shifts in which the roadway shall be returned to full public use within 12 hours or less may be placed on NCHRP350 approved portable sign frames.
- If the backing on the signs need to be affixed, the new spacing must be approved by the Project Engineer.

**FLASHING ARROW PANELS**

- Flashing Arrow Panels shall be used for lane closures on all roadways with 2 or more lanes in a single direction and a speed limit greater than 35 mph.
- When used, flashing arrow panels should be located on the shoulder at the beginning of the taper.
- Where the shoulder width is limited, the flashing arrow panel should be placed within the closed area as close to the beginning of the taper as practical.
- All Flashing Arrow Panels used on high speed roadways (45 mph and greater) shall be 4' x 8' Type C.
- When Flashing Arrow Panels signs are not being used, they should be removed. If not removed, they should be shielded by guardrail or barriers; or if the previous two options are not feasible, they should be delineated with retroreflective TTC devices.

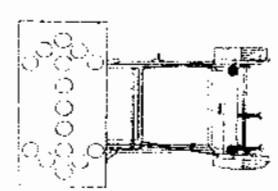

**PORTABLE CHANGEABLE MESSAGE SIGNS**

- When working within the traveled way, including shoulders and auxiliary lanes, Changeable Message Signs (CMS) shall be used on all interstate highways and on all other roadways where space is available with an ADT greater than 20,000 and should be delineated with retroreflective TTC devices. CMS will be paid for by each.
- When used in accordance with 6 lane closures or a lane shift, the CMS should be placed on the right hand side of the road a minimum distance of 2 miles at entrance at the taper for interchanges and to be delineated by the Engineer on other highways.
- If vehicles are queue beyond the 2 mile CMS, an additional CMS should be placed on the right hand side of the road approximately 3 miles at entrance of the taper for interchanges.
- CMS messages shall be approved by the District Traffic Operations Engineer (DIOE).
- When Portable Changeable Message signs are not being used, they should be removed. If not removed, they should be shielded by guardrail or barriers; or if the previous two options are not feasible, they should be delineated with retroreflective TTC devices.

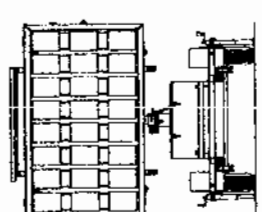

**CHANNELIZING DEVICES**

- The following devices may be used:
  - Tubular Markers, Vertical Panels, Cones, Drums, and Super Cones.
  - Drums (for standard roadwork) and Super Cones (for roadwork spacing) for the only device allowed to be used in taper areas.
  - On the delineation system during daylight hours. Only drums can be used in taper areas during night operations.
  - A distance of alternating devices in a taper should not exceed a maximum of 50 feet.
  - The spacing of channelizing devices in a taper should not exceed a distance of 100 feet on all interchanges, 125' and 36' cones are not allowed. 21 drums are the only device allowed in the taper.
  - Retroreflective material patterns used on super cones shall match that used on drums.
  - 20' traffic cones are not allowed on all interchanges.
  - 20' traffic cones are not allowed on all interchanges, 125' and 36' cones are not allowed. 21 drums are the only device allowed in the taper.

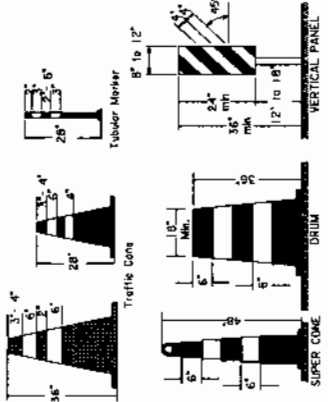

**FLAGGERS**

- All flaggers must be qualified. The contractor shall be responsible for training or assuring that of flaggers are qualified to perform flagging duties. A Qualified Flagger is one that has completed courses such as those approved by the American Traffic Safety Association (ATSSA), The Associated General Contractors of America (AGC) or other courses approved by the Louisiana DOTD's work zone Task Force. The contractor shall be responsible for getting the flagger certified.
- When utilized, a flagger shall use a minimum - 20 inch octagonal shape sign on a minimum 6' tripod and wear ANSI Class 2 Lime Green vest during day time operations and ANSI Class 3 Lime Green vest during night operations. In all flagging operations, the flagger must be visible from the flagger advance warning sign.

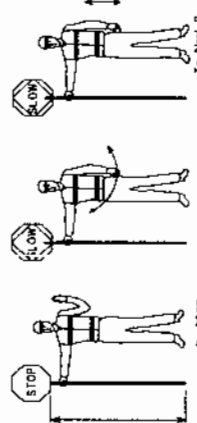

**ALLOWABLE LAP JOINT FOR U-CHANNEL POST**

- U-Channel posts may be spaced where long lengths are required. The upper section shall overlap the lower section by at least 24 inches. The bottom edge of the upper section of the splice shall be a minimum of 24 inches above the ground. The spliced sections shall be secured with at least two 1/2 inch diameter hot bolts spaced equally along the splice.

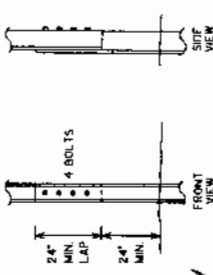

**TYPE III BARRICADES**

- All barricades shall use Type 3 High Intensity Sheeting on both sides of the barricade.
- All Type III Barricades shall be a minimum of 8 feet in length and must meet NCHRP 350 requirements.
- When signs and lights are to be mounted to a barricade, they must meet NCHRP 350 requirements.



**PAVEMENT MARKINGS (see OPL)**

- All pavement markings within the limits of the project that are in conflict with the project signing or the required traffic movements shall be removed from the pavement by best cleaning or grinding. Existing striping shall not be painted over with black paint or covered with tape.
- If special pavement markings are needed, they shall be reflectorized, removed, and accompanied by the proper signing.
- Temporary Raised Pavement Markers (RPMs) may be added to supplement temporary striping in areas of transition, in tapers, in detours, and in other areas of need as directed by the Project Engineer.
- Markings and placement of temporary pavement markings shall conform to section 7.13 of the Standard Specifications. If no pavement exists, temporary markings will be considered incidental to traffic control.

**SPEED LIMITS**

- Speed limits shall be lowered by 10 mph for any construction, maintenance, or utility operation that requires one or more of the following:
  - (A) The existence of the original highway is degraded due to mixed surfaces or uneven pavements.
  - (B) Work is in progress in the immediate vicinity of the travel way requiring lane closures, lane shifts, reductions, or low speed diversions.
  - (C) Workers present on the shoulder within 2' of the edge of traveled way without barrier protection.
- The reduced speed zone shall only apply to those portions of the project limits affected. The Project Engineer may allow SPEED LIMIT WHEN FLASHING signs to supplement reduced speed zones.
- At the end of the reduced speed zone, a speed limit sign displaying the original speed limit before construction shall be installed.
- If conditions warrant, the District Traffic Operations Engineer may authorize the reduction of the speed limit by more than 10 mph.

**GENERAL PROVISIONS**

- All signs used for temporary traffic control shall follow the Department's Traffic Control (TC) device and the MUTCD. Signs shown in the TC Instructions are typical and may vary with each specific condition.
- More appropriate signing for a specific condition may be required or substituted with the approval of the Project Engineer and reviewed by the District Traffic Operations Engineer.
- When projects are resurfaced by less than one mile, they shall be signed as one project.
- At no time and sign working against a particular operation be left in place once the operation has been completed or where the obstacle has been removed.
- Signs over 10 sq ft shall be mounted on two post and signs over 20 sq ft shall be mounted on at least three post.
- Signs shall have a minimum of two bolts per post.
- Permanent signs no longer applicable or in conflict shall be removed or covered with a strong, lightweight, opaque material.
- Warning signs used for temporary traffic control shall meet the following guidelines unless otherwise noted in the plans:
  - (A) Size shall be 48" x 48" (B) See the Department's Standard Specifications and the OPL for sheeting information. (C) A minimum of a 2 lb U-Channel post shall be used driven to a minimum depth of 3'. (D) Sign height shall be a minimum of 5' above the roadway surface unless there is a concern for pedestrian or bicycle traffic, in which it shall be a minimum of 7'. (E) Lateral offsets of signs shall be a minimum of 5' from the edge or shoulder or edge of pavement if no shoulder exists and 2' from the back of curb in urban areas.
  - Vertical signs shall be placed so that they meet all size, color, reflectivity requirements, and NCHRP 350.
  - All signs shall be removed or covered when no longer applicable.
  - Contractor shall use caution not to damage existing signs which remain in place. Any DOTD signs damaged by work operations shall be replaced.

**FLAGGING MESSAGE SIGNS**

- When working within the traveled way, including shoulders and auxiliary lanes, Changeable Message Signs (CMS) shall be used on all interstate highways and on all other roadways where space is available with an ADT greater than 20,000 and should be delineated with retroreflective TTC devices. CMS will be paid for by each.
- When used in accordance with 6 lane closures or a lane shift, the CMS should be placed on the right hand side of the road a minimum distance of 2 miles at entrance at the taper for interchanges and to be delineated by the Engineer on other highways.
- If vehicles are queue beyond the 2 mile CMS, an additional CMS should be placed on the right hand side of the road approximately 3 miles at entrance of the taper for interchanges.
- CMS messages shall be approved by the District Traffic Operations Engineer (DIOE).
- When Portable Changeable Message signs are not being used, they should be removed. If not removed, they should be shielded by guardrail or barriers; or if the previous two options are not feasible, they should be delineated with retroreflective TTC devices.

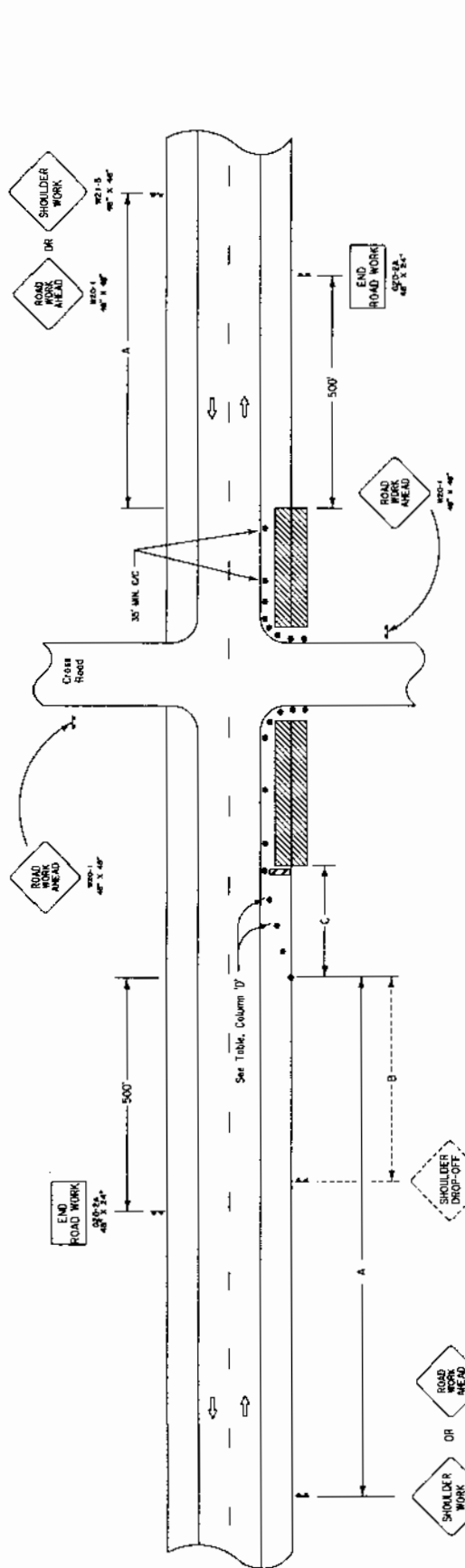

SPEED LIMIT	Spacing		Shoulder Closure Top	
	'A'	'B'	Minimum Length	Maximum Device Spacing
35 mph	500'	250'	100'	25'
45 mph	1000'	350'	200'	45'
≥ 55 mph	1500'	500'	250'	50'

If horizontal curve radius is less than 300', device spacing shall be 25'.

- NOTES**
- THIS SHEET SHALL BE USED WITH THE "TEMPORARY TRAFFIC CONTROL GENERAL NOTES SHEET (TC-00)".
- THIS LAYOUT REPRESENTS TRAFFIC CONTROL REQUIRED FOR WORKERS AND EQUIPMENT OPERATING WITHIN THE CLEAR ZONE FOR WORK THAT IS SHORTER THAN 150 FEET. IF THE WORK IS LONGER THAN 150 FEET, THE MITOS PORTABLE SIGNS MAY BE USED FOR WORK LASTING LESS THAN 3 DAYS.
  - NO SIGNS OR BARRICADES ARE REQUIRED FOR EQUIPMENT OPERATING OR WORK IN PROGRESS OUTSIDE THE CLEAR ZONE.
  - SIGNS AND BARRICADES SHALL BE COVERED OR REMOVED DURING NONWORKING HOURS UNLESS A DROP-OFF OR PHYSICAL OBSTRUCTION REMAINS WITHIN THE CLEAR ZONE.
  - TRAFFIC CONES MAY BE USED AS CHANNELIZING DEVICES ALONG THE WORK AREA DURING DAYLIGHT HOURS ONLY.
  - WORK OR EQUIPMENT CONFINED TO A SPOT LOCATION (LESS THAN 200 FEET) SHALL BE MARKED BY CHANNELIZING DEVICES SPACED AT 25 FEET OR BY A VEHICLE WITH A YELLOW REVOLVING LIGHT OR YELLOW STROBE LIGHT (WHICH IS CONSIDERED TO BE A TRAFFIC CONTROL DEVICE). THE LENGTH OF THE WORK AREA SHALL BE MARKED WITH APPROPRIATE DEVICES SPACED AS NOTED IN THE TABLE.
  - NO SIGNS OR BARRICADES ARE REQUIRED FOR EQUIPMENT OPERATING OR WORK IN PROGRESS OUTSIDE THE CLEAR ZONE.
  - A TEMPORARY EDGE LINE OR CHANNELIZING DEVICE SHALL BE PLACED AT THE PAVEMENT EDGE ADJACENT TO THE DROP-OFF DURING NONWORKING HOURS WHEN THE DROPOFF IS GREATER THAN 2'.
  - SPEED LIMIT IN THE ABOVE TABLE REFERS TO THE LEGALLY ESTABLISHED SPEED LIMIT BEFORE CONSTRUCTION. IF WORKERS ARE PRESENT WITHIN 2' OF TRAVEL LANE, SPEED LIMIT MAY NEED TO BE REDUCED.
  - WHEN A WORK AREA HAS BEEN ESTABLISHED ON ONE SIDE OF THE ROADWAY OPPOSITE SHOULDER WITHIN 500 FEET OF THE WORK AREA, ANY SIGNS IN CONFLICT WITH CONSTRUCTION SIGNING SHALL BE REMOVED OR COVERED.
  - MINIMUM CONSTRUCTION SIGNING: ANY ADDITIONAL SIGNS SHOWN IN THE WORK AREA SHALL BE TRAFFIC CONTROL DEVICES AND REQUIRED BY THE PROJECT ENGINEER SHALL BE INSTALLED UNDER ITEM 715-01.
  - TYPE III BARRICADES SHALL BE PLACED IN THE CLOSED LANE AT A 1000' INTERVAL WHERE NO ACTIVE WORK IS ON GOING AND THE LANE MUST REMAIN UNOCCUPIED FOR AT LEAST 15 MINUTES BEFORE EACH GROUP OF UNFILLED HOLES OR HOLES FILLED WITH TEMPORARY MATERIAL, OR WHERE UNCURED CONCRETE EXISTS.



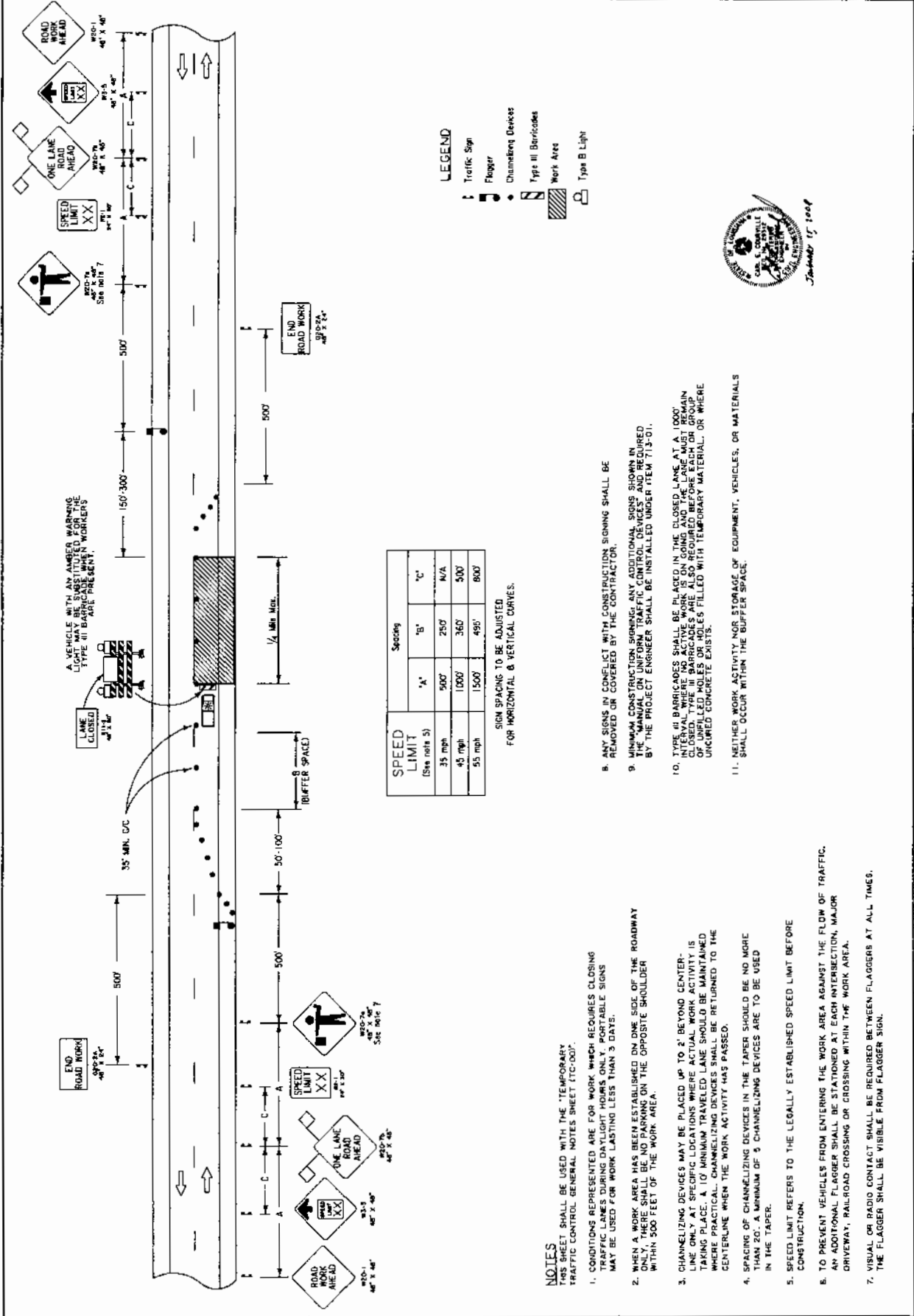

- NOTES**
- THIS SHEET SHALL BE USED WITH THE "TEMPORARY TRAFFIC CONTROL GENERAL NOTES SHEET (TC-001)".
  - CONDITIONS REPRESENTED ARE FOR WORK WHICH REQUIRES CLOSING TRAFFIC LANES DURING DAYLIGHT HOURS ONLY. PORTABLE SIGNS MAY BE USED FOR WORK LASTING LESS THAN 3 DAYS.
  - WHEN A WORK AREA HAS BEEN ESTABLISHED ON ONE SIDE OF THE ROADWAY ONLY, THERE SHALL BE NO PARKING ON THE OPPOSITE SHOULDER WITHIN 500 FEET OF THE WORK AREA.
  - CHANNELIZING DEVICES MAY BE PLACED UP TO 2' BEYOND CENTER-LINE ONLY AT SPECIFIC LOCATIONS WHERE ACTUAL WORK ACTIVITY IS TAKING PLACE. A 10' MINIMUM TRAVELED LANE SHOULD BE MAINTAINED WHERE PRACTICAL. CHANNELIZING DEVICES SHALL BE RETURNED TO THE CENTERLINE WHEN THE WORK ACTIVITY HAS PASSED.
  - SPACING OF CHANNELIZING DEVICES IN THE TAPER SHOULD BE NO MORE THAN 20'. A MINIMUM OF 9 CHANNELIZING DEVICES ARE TO BE USED IN THE TAPER.
  - SPEED LIMIT REFERS TO THE LEGALLY ESTABLISHED SPEED LIMIT BEFORE CONSTRUCTION.
  - TO PREVENT VEHICLES FROM ENTERING THE WORK AREA AGAINST THE FLOW OF TRAFFIC, AN ADDITIONAL FLAGGER SHALL BE STATIONED AT EACH INTERSECTION, MAJOR DRIVEWAY, RAILROAD CROSSING OR CROSSING WITHIN THE WORK AREA.
  - VISUAL OR RADIO CONTACT SHALL BE REQUIRED BETWEEN FLAGGERS AT ALL TIMES. THE FLAGGER SHALL BE VISIBLE FROM FLAGGER SIGN.

- ANY SIGNS IN CONFLICT WITH CONSTRUCTION SIGNING SHALL BE REMOVED OR COVERED BY THE CONTRACTOR.
- MINIMUM CONSTRUCTION SIGNING, ANY ADDITIONAL SIGNS SHOWN IN THE "MANUAL ON UNIFORM TRAFFIC CONTROL DEVICES" AND REQUIRED BY THE PROJECT ENGINEER SHALL BE INSTALLED UNDER ITEM 713-01.
- TYPE III BARRICADES SHALL BE PLACED IN THE CLOSED LANE AT A 1000' MINIMUM SPACING FROM THE WORK AREA. TYPE III BARRICADES SHALL BE PLACED IN THE CLOSED LANE AT A 10' MINIMUM TRAVELED LANE SHOULD BE MAINTAINED WHERE PRACTICAL. CHANNELIZING DEVICES SHALL BE RETURNED TO THE CENTERLINE WHEN THE WORK ACTIVITY HAS PASSED.
- NEITHER WORK ACTIVITY NOR STORAGE OF EQUIPMENT, VEHICLES, OR MATERIALS SHALL OCCUR WITHIN THE BUFFER SPACE.



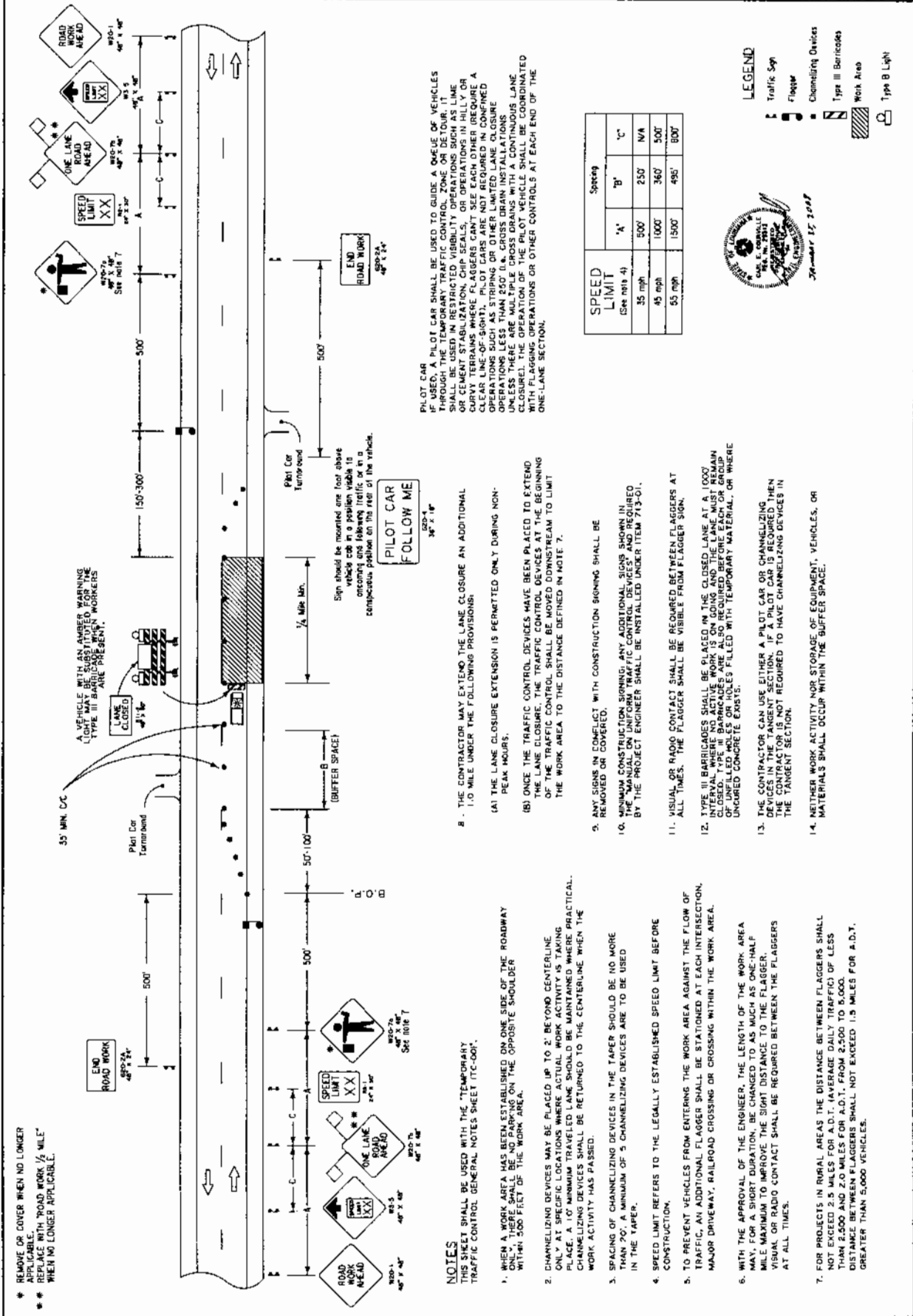

\* REMOVE OR COVER WHEN NO LONGER APPLICABLE.  
 \*\* REPLACE WITH "ROAD WORK 1/4 MILE" WHEN NO LONGER APPLICABLE.

**NOTES**

- THIS SHEET SHALL BE USED WITH THE "TEMPORARY TRAFFIC CONTROL GENERAL NOTES SHEET TFC-001".
- WHEN A WORK AREA HAS BEEN ESTABLISHED ON ONE SIDE OF THE ROADWAY ONLY, THERE SHALL BE NO PARKING ON THE OPPOSITE SHOULDER WITHIN 500 FEET OF THE WORK AREA.
- CHANNELIZING DEVICES MAY BE PLACED UP TO 2' BEYOND CENTERLINE ONLY AT SPECIFIC LOCATIONS WHERE ACTUAL WORK ACTIVITY IS TAKING PLACE. A 10' MINIMUM TRAVELED LANE SHOULD BE MAINTAINED WHERE PRACTICAL. CHANNELIZING DEVICES SHALL BE RETURNED TO THE CENTERLINE WHEN THE WORK ACTIVITY HAS PASSED.
- SPACING OF CHANNELIZING DEVICES IN THE TAPER SHOULD BE NO MORE THAN 20'. A MINIMUM OF 5 CHANNELIZING DEVICES ARE TO BE USED IN THE TAPER.
- SPEED LIMIT REFERS TO THE LEGALLY ESTABLISHED SPEED LIMIT BEFORE CONSTRUCTION.
- TO PREVENT VEHICLES FROM ENTERING THE WORK AREA AGAINST THE FLOW OF TRAFFIC, AN ADDITIONAL FLAGGER SHALL BE STATIONED AT EACH INTERSECTION, MAJOR DRIVEWAY, RAILROAD CROSSING OR CROSSING WITHIN THE WORK AREA.
- WITH THE APPROVAL OF THE ENGINEER, THE LENGTH OF THE WORK AREA MAY, FOR A SHORT DURATION, BE CHANGED TO AS MUCH AS ONE-HALF MILE MAXIMUM TO IMPROVE THE SIGHT DISTANCE TO THE FLAGGER. VISUAL OR RADIO CONTACT SHALL BE REQUIRED BETWEEN THE FLAGGERS AT ALL TIMES.
- FOR PROJECTS IN RURAL AREAS THE DISTANCE BETWEEN FLAGGERS SHALL NOT EXCEED 2.5 MILES FOR A.D.T. (AVERAGE DAILY TRAFFIC) OF LESS THAN 2,000 AND 2.0 MILES FOR A.D.T. FROM 2,000 TO 5,000. DISTANCE BETWEEN FLAGGERS SHALL NOT EXCEED 1.5 MILES FOR A.D.T. GREATER THAN 5,000 VEHICLES.

PILOT CAR IF USED, A PILOT CAR SHALL BE USED TO GUIDE A QUEUE OF VEHICLES THROUGH THE TEMPORARY TRAFFIC CONTROL ZONE OR DETOUR. IT SHALL BE USED IN RESTRICTED VISIBILITY OPERATIONS SUCH AS LINE CLEARANCE, ROAD REPAIRS, OR OPERATIONS IN HILL OR CURVE TERRAINS WHERE THE PILOT CAR IS NOT IN A CLEAR LINE-OF-SIGHT. PILOT CARS ARE NOT REQUIRED IN CONFINED OPERATIONS SUCH AS STRIPING OR OTHER LIMITED LANE CLOSURE OPERATIONS LESS THAN 200' (i.e. GROSS DRAIN INSTALLATIONS UNLESS THERE ARE MULTIPLE CROSS DRAINS WITH A CONTINUOUS LANE WITH FLAGGING OPERATIONS OR THE PILOT VEHICLE SHALL BE COORDINATED WITH FLAGGING OPERATIONS OR OTHER CONTROLS AT EACH END OF THE ONE-LANE SECTION.

B. THE CONTRACTOR MAY EXTEND THE LANE CLOSURE AN ADDITIONAL 1.0 MILE UNDER THE FOLLOWING PROVISIONS:

- THE LANE CLOSURE EXTENSION IS PERMITTED ONLY DURING NON-PEAK HOURS.
- ONCE THE TRAFFIC CONTROL DEVICES HAVE BEEN PLACED TO EXTEND THE LANE CLOSURE, THE TRAFFIC CONTROL DEVICES AT THE BEGINNING OF THE WORK AREA TO THE DISTANCE DEFINED IN NOTE 7.

9. ANY SIGNS IN CONFLICT WITH CONSTRUCTION SIGNING SHALL BE REMOVED OR COVERED.

10. MINIMUM CONSTRUCTION SIGNING, ANY ADDITIONAL SIGNS SHOWN IN THE MANUAL ON UNIFORM TRAFFIC CONTROL DEVICES AND REQUIRED BY THE PROJECT ENGINEER SHALL BE INSTALLED UNDER ITEM 713-01.

11. VISUAL OR RADIO CONTACT SHALL BE REQUIRED BETWEEN FLAGGERS AT ALL TIMES. THE FLAGGER SHALL BE VISIBLE FROM FLAGGER SIGN.

12. TYPE III BARRICADES SHALL BE PLACED IN THE CLOSED LANE AT A 1000' INTERVAL WHERE NO ACTIVE WORK IS ON GOING AND THE LANE MUST REMAIN UNCLOSED. WHERE CHANNELIZING DEVICES ARE USED TO CHANNELIZE UNCLOSED CONCRETE EXISTS.

13. THE CONTRACTOR CAN USE EITHER A PILOT CAR OR CHANNELIZING DEVICES TO PROTECT THE WORK AREA. A PILOT CAR IS REQUIRED WHEN THE CONTRACTOR IS NOT REQUIRED TO HAVE CHANNELIZING DEVICES IN THE TANGENT SECTION.

14. NEITHER WORK ACTIVITY NOR STORAGE OF EQUIPMENT, VEHICLES, OR MATERIALS SHALL OCCUR WITHIN THE BUFFER SPACE.



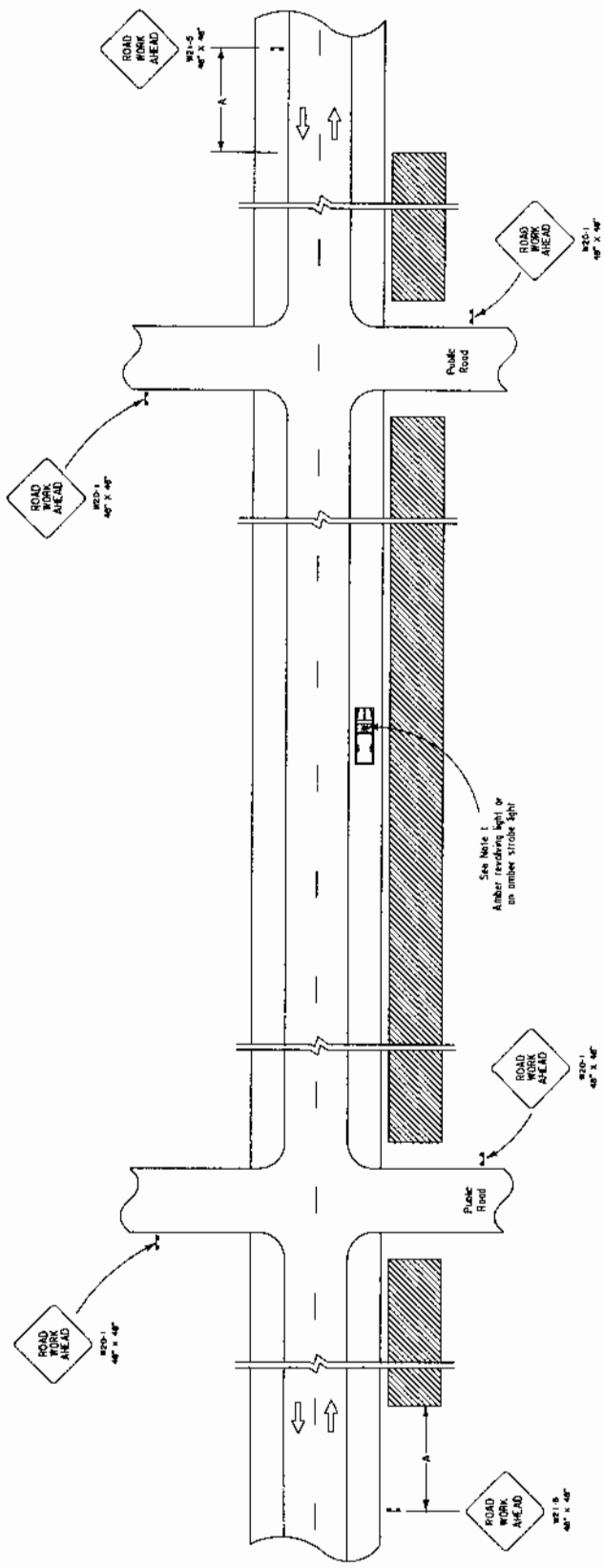

**NOTES**

THIS SHEET SHALL BE USED WITH THE TEMPORARY TRAFFIC CONTROL GENERAL NOTES SHEET (TC-001).

1. THIS LAYOUT REPRESENTS TRAFFIC CONTROLS REQUIRED FOR WORKERS AND EQUIPMENT OPERATING OUTSIDE OF CLEAR ZONE. IF THE OPERATION RESULTS IN EQUIPMENT OR OTHER VEHICLES BEING PARKED WITHIN THE CLEAR ZONE, BUT NOT WITHIN THE ROADWAY EACH VEHICLE SHALL HAVE AN AMBER LIGHT.
2. WHEN A WORK AREA HAS BEEN ESTABLISHED ON ONE SIDE OF THE ROADWAY ONLY, THERE SHALL BE NO PARKING ON THE OPPOSITE SHOULDER WITHIN 500 FEET OF THE WORK AREA.
3. SPEED LIMIT REFERS TO THE LEGALLY ESTABLISHED SPEED LIMIT BEFORE CONSTRUCTION.
4. AN ADDITIONAL "ROAD WORK AHEAD" SIGN SHALL BE PLACED AT EACH PUBLIC ROAD INTERSECTING THE PROJECT WITHIN THE WORK AREA.
5. ANY SIGNS IN CONFLICT WITH CONSTRUCTION SIGNING SHALL BE REMOVED OR COVERED.
6. MINIMUM CONSTRUCTION SIGNING: ANY ADDITIONAL SIGNS SHOWN IN THE "MANUAL ON UNIFORM TRAFFIC CONTROL DEVICES" AND REQUIRED BY THE PROJECT ENGINEER SHALL BE INSTALLED UNDER ITEM 713-D1.

**LEGEND**

- Traffic Sign
- Work Area

SPEED LIMIT	Spacing
35 mph	500'
45 mph	1000'
55 mph	1500'



**STATE OF LOUISIANA  
DEPARTMENT OF TRANSPORTATION AND  
DEVELOPMENT**



**CONSTRUCTION PROPOSAL  
RETURNABLES  
FOR**

**STATE PROJECT NO. 737-96-0076  
TREE AND STUMP REMOVAL IN DISTRICT 61  
DISTRICTWIDE**

G-1

**For Informational Purposes Only – Not Valid For Bid Submittal**



# BID BOND

A Bid Bond is required when the bidder's total bid amount as calculated by the Department in accordance with Subsection 103.01 is greater than \$50,000. (See Section 102 of the Project Specifications.)

\_\_\_\_\_, as Principal  
(Bidder) and \_\_\_\_\_, as Surety,  
are bound unto the State of Louisiana, Department of Transportation and Development, (hereinafter called the Department) in the sum of five percent (5%) of the bidder's total bid amount as calculated by the Department for payment, of which the Principal and Surety bind themselves, their heirs, executors, administrators, successors and assigns, as solidary obligors.

Signed and sealed this \_\_\_\_\_ day of \_\_\_\_\_, 20\_\_\_\_\_.

The condition of this obligation is such that, whereas the Principal has submitted a bid to the Department on a contract for the construction of **STATE PROJECT NO. 737-96-0076, TREE AND STUMP REMOVAL IN DISTRICT 61, DISTRICTWIDE, located in DISTRICT 61**, if the bid is accepted and the Principal, within the specified time, enters into the contract in writing and gives bond with Surety acceptable to the Department for payment and performance of said contract, this obligation shall be void; otherwise to remain in effect.

_____ Principal (Bidder or First Partner to Joint Venture) By _____ Authorized Officer-Owner-Partner _____ Typed or Printed Name	_____ If a Joint Venture, Second Partner By _____ Authorized Officer-Owner-Partner _____ Typed or Printed Name
---	---

\_\_\_\_\_  
Surety  
By \_\_\_\_\_ (Seal)  
Agent or Attorney-in-Fact  
\_\_\_\_\_  
Typed or Printed Name

To receive a copy of the contract and subsequent correspondence / communication from LA DOTD, with respect to the bid bonds, the following information must be provided:

_____ Bonding Agency or Company Name	_____ Address
_____ Agent or Representative	_____ Phone Number / Fax Number

LOUISIANA DEPARTMENT OF TRANSPORTATION AND DEVELOPMENT  
 SCHEDULE OF ITEMS

LEAD PROJECT: 737-96-0076  
 OTHER PROJECTS:

DATE: 06/05/09 15:29 PAGE: 1

ITEM NUMBER	APPROXIMATE QUANTITY	UNIT OF MEASURE	PAY ITEM UNIT PRICE (IN WORDS, INK OR TYPED)
S-001	2	EACH	TREE AND STUMP REMOVAL (UNDER 36" - 36" DIAMETER) _____ DOLLARS _____ CENTS
S-002	11	EACH	TREE AND STUMP REMOVAL (OVER 36" - 48" DIAMETER) _____ DOLLARS _____ CENTS
S-003	11	EACH	TREE AND STUMP REMOVAL (OVER 48" DIAMETER) _____ DOLLARS _____ CENTS

# CONSTRUCTION PROPOSAL SIGNATURE AND EXECUTION FORM

THIS FORM, THE SCHEDULE OF ITEMS, AND THE PROPOSAL GUARANTY MUST BE COMPLETED AS INDICATED AND SUBMITTED TO THE LOUISIANA DEPARTMENT OF TRANSPORTATION AND DEVELOPMENT (DOTD) TO CONSTITUTE A VALID BID

STATE PROJECT NO(S). 737-96-0067

FEDERAL AID PROJECT NO(S). N/A

NAME OF PROJECT TREE AND STUMP REMOVAL IN DISTRICT 61

I (WE) HEREBY CERTIFY THAT I (WE) HAVE CAREFULLY EXAMINED THE PROPOSAL, PLANS AND SPECIFICATIONS, INCLUDING ANY AND ALL ADDENDA, AND THE SITE OF THE ABOVE PROJECT AND AM (ARE) FULLY COGNIZANT OF ALL PROPOSAL DOCUMENTS, THE MASTER COPY OF WHICH IS ON FILE AT DOTD HEADQUARTERS IN BATON ROUGE, LA., AND ALL WORK, MATERIALS AND LABOR REQUIRED THEREIN, AND AGREE TO PERFORM ALL WORK, AND SUPPLY ALL NECESSARY MATERIALS AND LABOR REQUIRED FOR SUCCESSFUL AND TIMELY COMPLETION OF THE ABOVE PROJECT AND TO ACCEPT THE SUMMATION OF THE PRODUCTS OF THE UNIT PRICES BID ON THE SCHEDULE OF ITEMS ATTACHED HERETO AND MADE A PART HEREOF MULTIPLIED BY THE ACTUAL QUANTITY OF UNIT OF MEASURE PERFORMED FOR EACH ITEM, AS AUDITED BY DOTD, AS FULL AND FINAL PAYMENT FOR ALL WORK, LABOR AND MATERIALS NECESSARY TO COMPLETE THE ABOVE PROJECT, SUBJECT TO INCREASE ONLY FOR PLAN CHANGES (CHANGE ORDERS) APPROVED BY THE DOTD CHIEF ENGINEER OR HIS DESIGNEE. THIS BID IS SUBMITTED IN ACCORDANCE WITH THE GENERAL BIDDING REQUIREMENTS IN THE CONSTRUCTION PROPOSAL AND ALL SPECIAL PROVISIONS, PLANS, SUPPLEMENTAL SPECIFICATIONS, AND THE LOUISIANA STANDARD SPECIFICATIONS FOR ROADS AND BRIDGES (2006 EDITION). I (WE) UNDERSTAND THAT THE SUMMATION OF THE PRODUCTS OF THE UNIT PRICES BID ON THE SCHEDULE OF ITEMS MULTIPLIED BY THE ESTIMATED QUANTITY OF UNIT OF MEASURE FOR EACH ITEM, ALONG WITH ANY OTHER FACTORS SPECIFIED TO BE APPLICABLE SUCH AS CONSTRUCTION TIME AND/OR LANE RENTAL, SHALL BE THE BASIS FOR THE COMPARISON OF BIDS. I (WE) UNDERSTAND THAT THE SCHEDULE OF ITEMS MUST CONTAIN UNIT PRICES WRITTEN OUT IN WORDS AND THAT THE SCHEDULE OF ITEMS SUBMITTED AS PART OF THIS BID IS ON THE FORM SUPPLIED BY DOTD IN THE BID PROPOSAL. MY (OUR) PROPOSAL GUARANTY IN THE AMOUNT SPECIFIED FOR THE PROJECT IS ATTACHED HERETO AS EVIDENCE OF MY (OUR) GOOD FAITH TO BE FORFEITED IF THIS BID IS ACCEPTED BY DOTD AND I (WE) FAIL TO COMPLY WITH ANY REQUIREMENT NECESSARY FOR AWARD AND EXECUTION OF THE CONTRACT, AS WELL AS, SIGN AND DELIVER THE CONTRACT AND PAYMENT/PERFORMANCE/RETAINAGE BOND AS REQUIRED IN THE SPECIFICATIONS.

## NONCOLLUSION DECLARATION (APPLICABLE TO FEDERAL-AID PROJECTS)

I (WE) DECLARE UNDER PENALTY OF PERJURY UNDER THE LAWS OF THE UNITED STATES AND THE STATE OF LOUISIANA THAT I (WE) HAVE NOT DIRECTLY OR INDIRECTLY, ENTERED INTO ANY AGREEMENT, PARTICIPATED IN ANY COLLUSION, OR OTHERWISE TAKEN ANY ACTION IN RESTRAINT OF FREE COMPETITIVE BIDDING IN CONNECTION WITH THE CONTRACT FOR THIS PROJECT NOR VIOLATED LA. R.S. 48:254.

## BIDDER'S DBE GOAL STATEMENT (APPLICABLE TO DBE GOAL PROJECTS)

IF THIS PROJECT IS DESIGNATED BY SPECIAL PROVISION AS A DISADVANTAGED BUSINESS ENTERPRISE (DBE) GOAL PROJECT IN ACCORDANCE WITH THE DBE PROVISIONS OF THIS CONTRACT, THE BIDDER ASSURES DOTD THAT HE/SHE WILL MEET OR EXCEED THE DBE CONTRACT GOAL, OR IF THE BIDDER CANNOT MEET THE REQUIRED DBE GOAL, THE BIDDER ASSURES DOTD THAT HE/SHE HAS MADE AND CAN DOCUMENT GOOD FAITH EFFORTS MADE TOWARDS MEETING THE GOAL REQUIREMENT IN ACCORDANCE WITH THE CONTRACT AND DBE PROGRAM MANUAL INCORPORATED HEREIN BY REFERENCE.

THE APPARENT LOW BIDDER SHALL COMPLETE AND SUBMIT TO THE DOTD COMPLIANCE PROGRAMS OFFICE, FORM CS-6AAA AND ATTACHMENT(S) AND, IF NECESSARY, DOCUMENTATION OF GOOD FAITH EFFORTS MADE BY THE BIDDER TOWARD MEETING THE GOAL, WITHIN TEN BUSINESS DAYS AFTER THE OPENING OF BIDS FOR THIS PROJECT. RESPONSIVENESS OF INFORMATION SUPPLIED IN THIS SECTION OF THIS CONSTRUCTION PROPOSAL SIGNATURE AND EXECUTION FORM IS GOVERNED BY THE DBE REQUIREMENTS INCLUDED WITHIN THE SPECIFICATIONS AND DBE PROGRAM MANUAL.

## CERTIFICATION OF EMPLOYMENT OF LOUISIANA RESIDENTS TRANSPORTATION INFRASTRUCTURE MODEL FOR ECONOMIC DEVELOPMENT (TIME) PROJECTS (APPLICABLE TO TIME PROJECTS)

IF THIS PROJECT IS DESIGNATED BY SPECIAL PROVISION AS A TRANSPORTATION INFRASTRUCTURE MODEL FOR ECONOMIC DEVELOPMENT (TIME) PROJECT AS DEFINED IN ACT NO. 16 OF THE 1989 FIRST EXTRAORDINARY SESSION OF THE LEGISLATURE WHICH ENACTED PART V OF CHAPTER 7 OF SUBTITLE II OF TITLE 47 OF THE LOUISIANA REVISED STATUTES OF 1950, COMPRISED OF R.S. 47:820.1 THROUGH 820.6.

THE BIDDER CERTIFIES THAT AT LEAST 80 PERCENT OF THE EMPLOYEES EMPLOYED ON THIS TIME PROJECT WILL BE LOUISIANA RESIDENTS IN ACCORDANCE WITH LOUISIANA R.S. 47:820.3.

## NON PARTICIPATION IN PAYMENT ADJUSTMENT (ASPHALT CEMENT AND FUELS) STATEMENT

IF THIS PROJECT IS DESIGNATED BY SPECIAL PROVISION AS BEING SUBJECT TO PAYMENT ADJUSTMENT FOR ASPHALT CEMENT AND/OR FUELS, THE BIDDER HAS THE OPTION OF REQUESTING EXCLUSION FROM SAID PAYMENT ADJUSTMENT PROVISIONS THAT ARE ESTABLISHED BY SPECIAL PROVISION ELSEWHERE HEREIN.

IF THE BIDDER DESIRES TO BE EXCLUDED FROM THESE PAYMENT ADJUSTMENT PROVISIONS,

THE BIDDER IS REQUIRED TO MARK HERE

FAILURE TO MARK THIS BOX PRIOR TO BID OPENING WILL CONSTITUTE FORFEITURE OF THE BIDDER'S OPTION TO REQUEST EXCLUSION.

CS-14A  
08/06

J-1

**For Informational Purposes Only – Not Valid For Bid Submittal**

**BIDDER SIGNATURE REQUIREMENTS** (APPLICABLE TO ALL PROJECTS)

THIS BID FOR THE CAPTIONED PROJECT IS SUBMITTED BY:

**Form Not Valid For Bid Submittal**

\_\_\_\_\_  
Name of Principal (Individual, Firm, Corporation, or Joint Venture)

\_\_\_\_\_  
If Joint Venture, Name of First Partner

\_\_\_\_\_  
(Louisiana Contractor's License Number of Bidder or First Partner to Joint Venture)

\_\_\_\_\_  
(Business Street Address)

\_\_\_\_\_  
(Business Mailing Address, if different)

\_\_\_\_\_  
\_\_\_\_\_  
(Area Code and Telephone Number of Business)

\_\_\_\_\_  
(Telephone Number and Name of Contact Person)

\_\_\_\_\_  
(Telecopier Number, if any)

\_\_\_\_\_  
If Joint Venture, Name of Second Partner

\_\_\_\_\_  
(Louisiana Contractor's License Number of Second Partner to Joint Venture)

\_\_\_\_\_  
(Business Street Address)

\_\_\_\_\_  
(Business Mailing Address, if different)

\_\_\_\_\_  
\_\_\_\_\_  
(Area Code and Telephone Number of Business)

\_\_\_\_\_  
(Telephone Number and Name of Contact Person)

\_\_\_\_\_  
(Telecopier Number, if any)

ACTING ON BEHALF OF THE BIDDER, THIS IS TO ATTEST THAT THE UNDERSIGNED DULY AUTHORIZED REPRESENTATIVE OF THE ABOVE CAPTIONED FIRM, CORPORATION OR BUSINESS, BY SUBMISSION OF THIS BID, AGREES AND CERTIFIES THE TRUTH AND ACCURACY OF ALL PROVISIONS OF THIS PROPOSAL, INCLUSIVE OF THE REQUIREMENTS, STATEMENTS, DECLARATIONS AND CERTIFICATIONS ABOVE AND IN THE SCHEDULE OF ITEMS AND PROPOSAL GUARANTY. EXECUTION AND SIGNATURE OF THIS FORM AND SUBMISSION OF THE SCHEDULE OF ITEMS AND PROPOSAL GUARANTY SHALL CONSTITUTE AN IRREVOCABLE AND LEGALLY BINDING OFFER BY THE BIDDER.

\_\_\_\_\_  
(Signature)

\_\_\_\_\_  
(Printed Name)

\_\_\_\_\_  
(Title)

\_\_\_\_\_  
(Date of Signature)

\_\_\_\_\_  
(Signature)

\_\_\_\_\_  
(Printed Name)

\_\_\_\_\_  
(Title)

\_\_\_\_\_  
(Date of Signature)

CONTRACTOR'S TOTAL BASE BID \$ \_\_\_\_\_

IT IS AGREED THAT THIS TOTAL, DETERMINED BY THE BIDDER, IS FOR PURPOSES OF OPENING AND READING BIDS ONLY, AND THAT THE LOW BID FOR THIS PROJECT WILL BE DETERMINED FROM THE EXTENSION AND TOTAL OF THE BID ITEMS BY DOTD.

CS-14AA  
08/06